

ENGLISH



CDI-E407

Canon

PowerShot G10

Camera User Guide



Getting Started

p. 9

Ensure that you read the Safety Precautions (pp. 248 – 257).

Confirming the Package Contents

The following items are included in the package. If something is missing please contact the retail outlet at which you purchased the product.

1 Camera



2 Battery Pack NB-7L (With Terminal Cover)

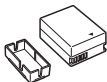

3 Battery Charger CB-2LZ/CB-2LZE



4 Interface Cable IFC-400PCU

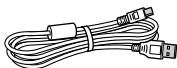

5 AV Cable AVC-DC300



6 Neck Strap NS-DC8



7 Canon Digital Camera Solution Disk





8 Warranty Card





9 "Canon Customer Support" Leaflet



10 User Guides

-  Camera User Guide (this guide)
-  Direct Print User Guide (Connecting the camera to a printer)
-  Software Starter Guide (Connecting the camera to a computer)

See the PDF manuals available on the Canon website.

-  ZoomBrowser EX/ImageBrowser Software User Guide (<http://web.canon.jp/imaging/information-e.html>)
-  Digital Photo Professional Instruction Manual

A memory card is not included.

Let's Get Started!

This guide is divided into the following two sections.

First...

Getting Started

p. 9

This section explains how to prepare the camera for use and the basics of shooting, viewing and printing images. Start out by familiarizing yourself with the camera and mastering the basics.

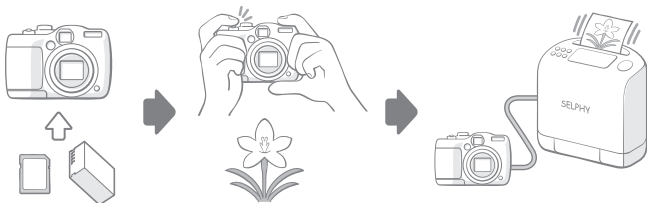

Next...

Learning More

p. 39



Once you have mastered the basics, use the camera's many features to shoot more challenging photos. Details on using each function are described in this section, including how to connect the camera to a television to view images.



Table of Contents

Items marked with a ☆ are lists or charts that summarize camera functions or procedures.

Please Read	7
-------------------	---

Getting Started	9
Preparations	10
Shooting Still Images ( Mode)	17
Viewing Still Images	19
Erasing	20
Printing	21
Shooting Movies ( Standard Mode)	24
Viewing Movies	26
Downloading Images to a Computer	27
System Map	34

Learning More 39



Components Guide 40









Using the Control Dial	43
Using the  Button	44
Indicators	45







Basic Operations 47

☆ Menus and Settings	47
☆ Information Displayed on the LCD Monitor and Menu ...	49
The LCD Monitor Display	63
Customizing Display Information	66

Commonly Used Shooting Functions 68

  Using the Optical Zoom	68
Using the Digital Zoom/ Digital Tele-Converter	69
 Using the Flash	73

 Shooting Close-ups (Macro)	74
 Using the Self-Timer	75
Changing the Recording Pixels (Still Images)	80
Changing the Compression (Still Images)	81
Changing the Image Type	82
Setting the Image Stabilizer Function	85
Adjusting the ISO Speed	87
Reducing Camera Shake When Shooting (Auto ISO Shift)	88
Shooting Using the Mode Dial	90
<hr/>	
Mode Dial	90
SCN Shooting Modes for Specific Scenes	91
P Program AE	95
Tv Setting the Shutter Speed	96
Av Setting the Aperture	98
M Manually Setting the Shutter Speed and Aperture	100
 Shooting Panoramic Images (Stitch Assist)	102
 Movie Shooting	104
Setting the Recording Functions	108
C Saving Custom Settings	109
Various Shooting Methods	111
<hr/>	
 Continuous Shooting	111
Setting the Flash	113
Checking the Focus and People's Expressions	116
Switching between Focus Settings	120
 Selecting an AF Frame Mode	121
Selecting a Subject to Focus On (Face Select and Track)	125
Shooting with Servo AF	127
Shooting Hard-to-Focus Subjects (Focus Lock, AF Lock, Manual Focus, Safety MF)	128
Focus Bracketing (Focus-BKT Mode)	133
 Locking the Exposure Setting (AE Lock)	134
 Locking the Flash Exposure Setting (FE Lock)	136
Adjusting the Exposure Compensation	137
Shooting while Brightening Dark Areas (i-Contrast)	138
Auto Exposure Bracketing (AEB Mode)	139

Using the ND Filter	140
 Switching between Metering Modes	141
Adjusting the Tone (White Balance)	143
Shooting in a My Colors Mode	146
Changing the Colors and Shooting	148
Categorizing Images Automatically (Auto Category)	154
Registering Functions to the  Button	155
Setting My Menu	157
Playback/Erasing	159
<hr/>	
 Viewing Magnified Images	159
 Viewing Images in Sets of Nine (Index Playback)	160
Checking the Focus and People's Expressions (Focus Check Display)	161
 Jumping to Images	163
Organizing Images by Category (My Category)	165
Trimming a Portion of an Image	168
Viewing Movies	171
Editing Movies	173
Rotating Images in the Display	175
Playback with Transition Effects	176
Automated Playback (Slide Shows)	177
Red-Eye Correction Function	182
Brightening Dark Areas (i-Contrast)	187
Adding Effects with the My Colors Function	189
Resizing Images	192
 Attaching Sound Memos to Images	194
Sound-Only Recording (Sound Recorder)	195
Protecting Images	197
Erasing Images	202
Print Settings/Transfer Settings	207
<hr/>	
Setting the DPOF Print Settings	207
Setting the DPOF Transfer Settings	214
Configuring the Camera	216
<hr/>	
Power Saving Function	216

Setting the World Clock	217
Low Level Formatting Memory Cards	220
Resetting the File Number	221
Creating an Image Destination (Folder).	223
Setting the Auto Rotate Function	225
Resetting Settings to Their Default Values	227
Connecting to a TV	228
Shooting/Playback Using a TV	228
Customizing the Camera (My Camera Settings)	230
Changing My Camera Settings	230
Registering My Camera Settings	231
Troubleshooting	233
List of Messages	244
Appendix	248
Safety Precautions	248
Preventing Malfunctions	254
Using the AC Adapter (Sold Separately)	258
Using the Lenses (Sold Separately)	260
Using an Externally Mounted Flash (Sold Separately)	265
Using a Supplementary Flash (Sold Separately)	272
Using the Remote Switch (Sold Separately)	274
Camera Care and Maintenance	275
Specifications	276
Index	286
Addendum	290
Attaching an Externally Mounted Flash (for Macro Ring Lite MR-14EX or Macro Twin Lite MT-24EX)	290
☆ Functions Available in Each Shooting Mode	300

About this Guide

Symbol Conventions in this Guide

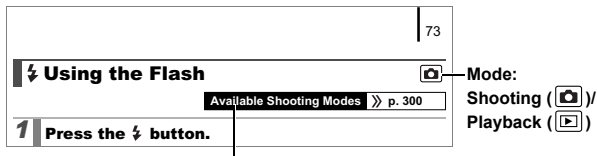

Some functions may not be available in certain shooting modes.
If there is no notation to that effect, the function may be used in all modes.



: This mark denotes issues that may affect the camera's operation.



: This mark denotes additional topics that complement the basic operating procedures.

Explanations in this guide are based on the camera's default settings at time of purchase.

The illustrations and screenshots used in this guide may differ from the actual camera.



You can use SD memory cards, SDHC (SD High Capacity) memory cards, MultiMediaCards, MMCplus cards and HC MMCplus cards in this camera. These are collectively referred to as memory cards in this guide.

Please Read

Test Shots

Before you try to photograph important subjects, we highly recommend that you shoot several trial images to confirm that the camera is operating and being operated correctly.

Please note that Canon Inc., its subsidiaries and affiliates, and its distributors are not liable for any consequential damages arising from any malfunction of a camera or accessory, including memory cards, that results in the failure of an image to be recorded or to be recorded in a way that is machine readable.

Warning Against Copyright Infringement

Please note that Canon digital cameras are intended for personal use and should never be used in a manner that infringes upon or contravenes international or domestic copyright laws and regulations. Please be advised that in certain cases the copying of images from performances, exhibitions, or commercial properties by means of a camera or other device may contravene copyright or other legal rights even if the image was shot for personal use.

Warranty Limitations

This camera's warranty is only effective in the country of sale. If a problem arises while the camera is in use abroad, please convey it back to the country of sale before proceeding with a warranty claim to a Canon Customer Support Help Desk.

For Canon Customer Support contacts, please see the customer support list supplied with your camera.

Camera Body Temperature

If your camera is used for prolonged periods, the camera body may become warm. Please be aware of this and take care when operating the camera for an extended period. This is not a malfunction.

About the LCD Monitor

The LCD monitor is produced with extremely high-precision manufacturing techniques. More than 99.99% of the pixels operate to specification. Less than 0.01% of the pixels may occasionally misfire or appear as red or black dots. This has no effect on the recorded image and does not constitute a malfunction.

Video Format

Please set the camera's video signal format to the one used in your region before using it with a TV monitor (p. 228).

Language Setting

Please see *Setting the Display Language* (p. 15) to change the language setting.

Getting Started

- **Preparations**
- **Shooting Still Images**
- **Viewing Still Images**
- **Erasing**
- **Printing**
- **Shooting Movies**
- **Viewing Movies**
- **Downloading Images to a Computer**
- **System Map**

Preparations

Charging the Battery

1. Insert the battery until it clicks into the battery charger.

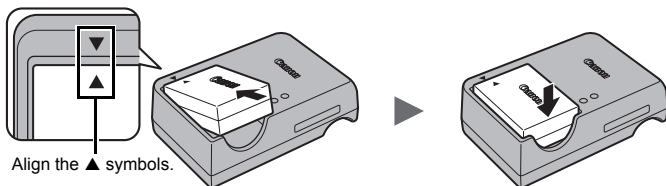

2. Plug the battery charger (CB-2LZ) into a power outlet, or attach the power cord to the battery charger (CB-2LZE) and plug it into a power outlet.

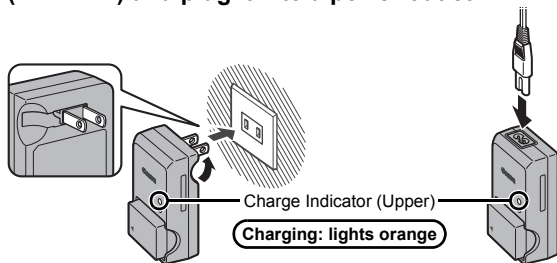

3. Remove the battery after charging is complete.

Charging takes approximately 2 hours 20 minutes.

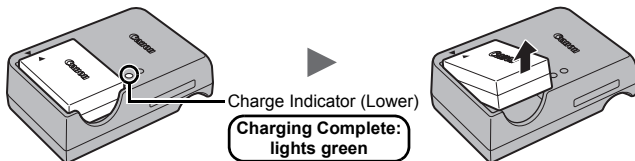

To protect the battery and prolong its life, do not charge it for longer than 24 hours continuously.

Installing the Battery and Memory Card

1. Slide the cover (①) and open it (②).

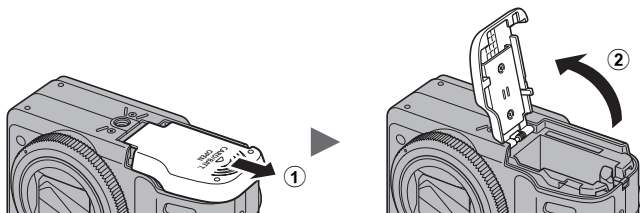

2. Push the battery lock in the direction of the arrow (③) and insert the battery until it locks.

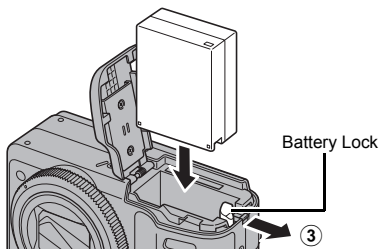

3. Insert the memory card until it clicks into place.

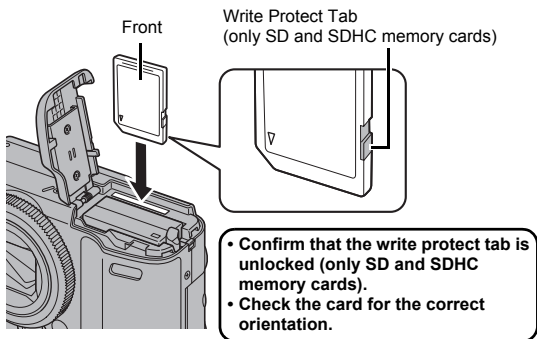

4. Close the cover (4) and slide until it clicks (5).

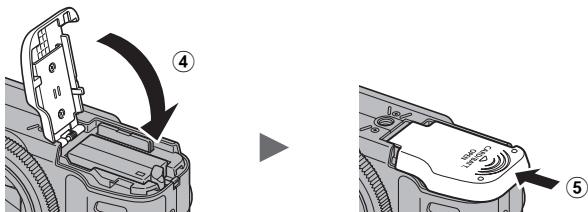

Ensure that the memory card is correctly oriented before inserting it in the camera. Inserting it backward may cause the camera to fail to recognize the memory card or to malfunction.

To Remove the Battery

Push the battery lock in the direction of the arrow and hold it while pulling the battery out.

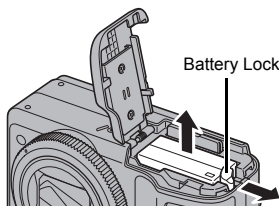

To Remove the Memory Card

Push the memory card with your finger until the memory card clicks and then release it.

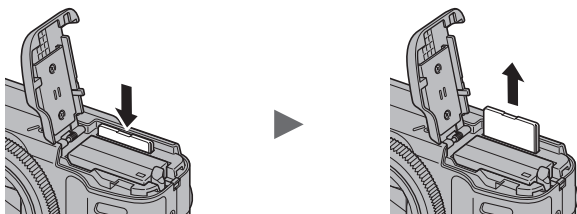

Attaching the Neck Strap



Pull the strap tight in the buckle so that it does not slip. Perform the same steps on the other side of the camera.



In order to avoid dropping the camera, we recommend attaching the neck strap before using the camera.

Setting the Date and Time

The Date/Time settings menu will appear the first time the power is turned on.

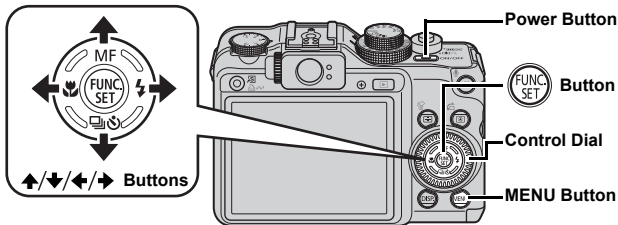

1. Press the power button.

2. Select the month, day, year and time, and the display order.

1. Use the \leftarrow or \rightarrow button to select an option.
2. Use the \uparrow or \downarrow button to set the value.

- You can also set the value by using the control dial.

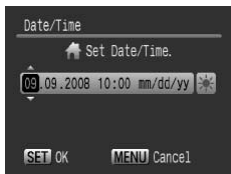

3. Press the  button.

To Change a Previously Set Date/Time

Use the following procedures to display the Date/Time settings menu, and then perform Steps 2 and 3 above.

1. Press the MENU button.

2. Use the \leftarrow or \rightarrow button to select the  (Set up) menu.

3. Use the \uparrow or \downarrow button to select [Date/Time].

4. Press the  button.











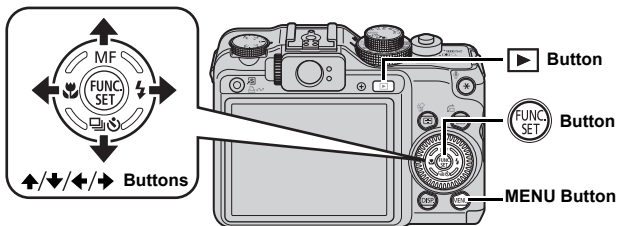

- A rechargeable lithium battery is built into the camera to save such settings as the date/time. If you insert a charged battery into the camera, or use the separately sold AC Adapter Kit ACK-DC50, the battery will charge in about four hours. It will charge even if the camera is turned off.
- The date/time settings may be lost after approximately three weeks if you remove the main battery. Reset the date/time settings if this occurs.

Setting the Display Language

You can change the language displayed in the LCD monitor menus and messages.





1. Press the  (Playback) button.
2. Hold down the  button and press the MENU button.
3. Use the , ,  or  button to select a language.
4. Press the  button.

Formatting Memory Cards

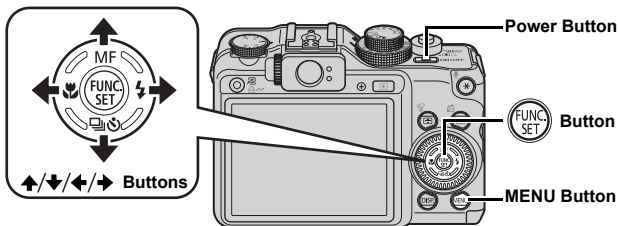
You should always format a new memory card or one from which you wish to erase all images and other data.



Please note that formatting (initializing) a memory card erases all data, including protected images (p. 197) and sound data recorded with the sound recorder (p. 195).

1. Press the power button.
2. Select [Format].
 1. Press the MENU button.
 2. Use the \leftarrow or \rightarrow button to select the  menu.
 3. Use the \uparrow or \downarrow button to select [Format].
 4. Press the  button.
3. Format a memory card.
 1. Use the \leftarrow or \rightarrow button to select [OK].
 2. Press the  button.

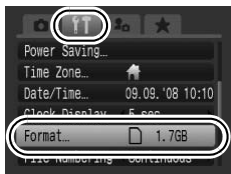

Displays when sound data recorded with the sound recorder is present.

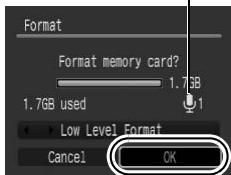

Shooting Still Images (AUTO Mode)

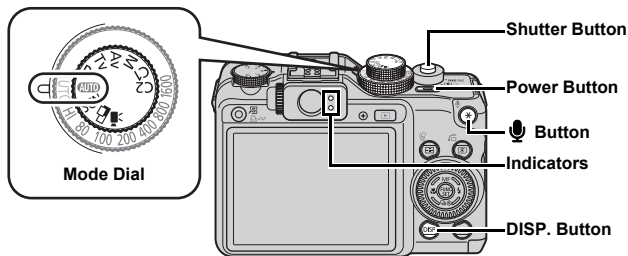

1. Press the power button.

- The start-up sound will play and the start-up image will display in the LCD monitor.
- Pressing the power button again turns the power off.

2. Select a shooting mode.

1. Set the mode dial to **AUTO**.

3. Aim the camera at the subject.



Avoiding Camera Shake

Keep your arms tight against your body while holding the camera firmly by the sides. Using a tripod is also effective.



4. Press the shutter button lightly (halfway) to focus.

When the camera focuses, it beeps twice and the indicator lights green (orange when the flash fires).

5. Press the shutter button fully (all the way) to shoot.

- The shutter sound will play and the image will record.
- Movement of the camera or subject while the shutter sound is playing may result in blurred images.
- Recorded images are displayed on the LCD monitor for approximately 2 seconds immediately after shooting (Rec. Review). You can shoot by pressing the shutter button even when an image is being displayed.
- If you hold the shutter button down after a shot, the image will continue to display.
- The indicator will blink green and the file will record to the memory card.

To Shoot Images in Focus

The camera automatically sets the focus when you press the shutter button halfway*.

* The shutter button has a two-stage action. Pressing it down to the first stage is referred to as "pressing halfway".

Correct

Press halfway
to set the focus

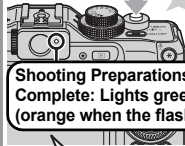

Beep,
beep...

Press fully



Recording:
Blinks green

Incorrect

Just pressing
fully



AF Frame

An AF frame will display in green on the LCD monitor at the point of focus.





Mute Setting

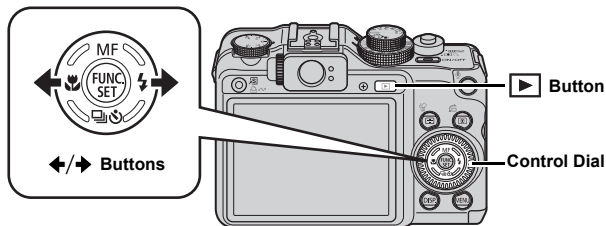

Pressing the  button while turning on the camera power will silence all camera sounds. You can change the setting in [Mute] in the Set up menu (p. 59).

Viewing Still Images



1. Press the  (Playback) button.

2. Use the  or  button to display the image you wish to view.

- Use the  button to move to the previous image and the  button to move to the next image.
- The images advance more quickly if you keep the button pressed, but they will appear coarse.
- You can also select images by using the control dial. Turning it counterclockwise displays the previous image while turning it clockwise displays the next image.



- In the Playback menu, you can set [Resume] to either [Last seen]* or [Last shot]. (* Default setting)
- If you select [Last seen], the last image viewed will display (Resume Playback).
- The following actions will display the most recent image regardless of the [Resume] settings: shooting an image, changing the memory card, or editing an image on the memory card using a computer.

Erasing

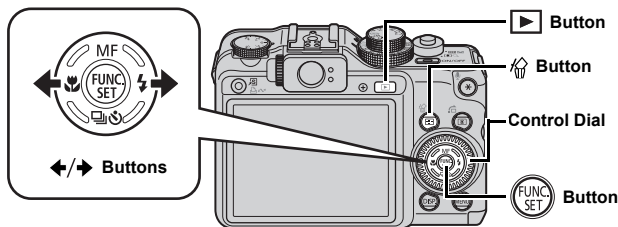

1. Press the (Playback) button.
2. Use the or button to select an image to erase and press the button.
3. Confirm that [Erase] is selected and press the button.

To exit instead of erasing, select [Cancel].



Please note that erased images cannot be recovered. Exercise adequate caution before erasing an image.

Printing

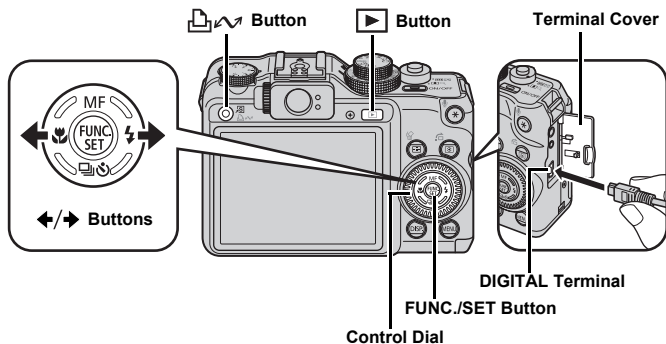

1. Connect the camera to a direct print compatible printer.

- Open the camera's terminal cover and insert the interface cable all the way into the terminal.
- See the printer's user guide for connection instructions.
- Since this camera uses a standard protocol (PictBridge), you can use it with other PictBridge-compliant printers in addition to Canon-brand printers.

For details, see the *Direct Print User Guide*.

2. Turn on the printer.

3. Press the camera's (Playback) button to turn on the power.

- The  button will light blue.

4. Use the **←** or **→** button to select an image to print and press the button.

- The  button will blink blue and printing will start.
- You can also select images by using the control dial.
- After you finish printing, turn off the camera and the printer and disconnect the interface cable.



This camera does not allow you to insert the shooting date into an image while shooting (date stamping). However, you can use the following method to imprint the date while printing.

- Set with the camera's Digital Print Order Format (DPOF) function (p. 207).

Set [Date] option to [On] in [Print Settings] in the  (Print) menu.

- Connect the camera to a printer and imprint the date.
See the *Direct Print User Guide*.
- Insert a memory card into the printer and imprint the date.
See your printer user guide.
- Use the supplied software.
See the *Software Starter Guide*.





Printing from a Print List



You can add images directly to a print list by merely pressing the  button immediately after shooting or playing back an image. You can then print the images from the print list easily, when connecting the camera to a printer.

Add to the Print List

1. Press the  button (still images only).

2. Add to the print list.

- Use the  or  button to select the number of print copies.
- Use the  or  button to select [Add].
- Press the  button.

- To remove an image from the print list, press the  button again, use the  or  button to select [Remove] and press the **FUNC./SET** button.







Printing Images in a Print List

This explanation is based on the use of a Canon SELPHY ES series or SELPHY CP series printer.

1. Connect the camera to the printer.

2. Print the image.

- Use the  or  button to select [Print now].
 - You can use the  or  button to confirm the images added to the print list.
- Press the  button.

- Printing will start.
- If printing is halted and resumed, printing will start from the next image in the queue.

Number of copies to print



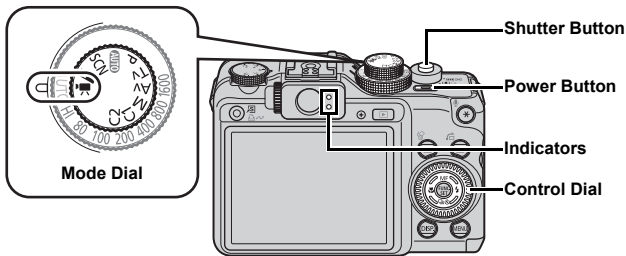

Shooting Movies (Standard Mode)



1. Press the power button.

2. Select a shooting mode.

1. Set the mode dial to  (Movie).
2. Use the control dial to select  (Standard).



3. Aim the camera at the subject.



- Do not touch the microphone while recording.
- The sound that buttons and other controls make when used will be recorded in the movie.

Microphone

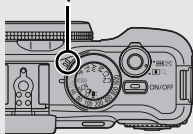

Top view

4. Press the shutter button halfway to focus.

- When the camera focuses, it beeps twice and the indicator lights green.
- The exposure, focus and white balance are automatically set.



5. Press the shutter button fully to shoot.

- Recording starts.
- During recording, the elapsed recording time and [●Rec.] will display in the LCD monitor.

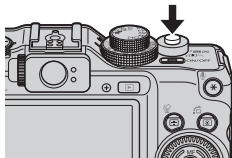

Elapsed Time

6. Press the shutter button fully again to stop recording.

- The indicator will blink green and the data will be recorded onto the memory card.
 - Max. Clip Size: 4 GB*.
 - Recording will stop automatically when the maximum recording time elapses, or the built-in memory or memory card become full.
- * Even before the recording size reaches 4 GB, recording will stop at the moment the recording time reaches 1 hour. Depending on memory card capacity and data write speed, recording may stop before the file size reaches 4 GB or the recording time reaches 1 hour.

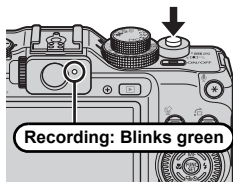

Viewing Movies

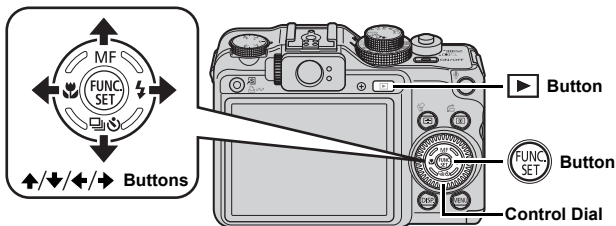

1. Press the ▶ (Playback) button.

2. Use the ◀ or ▶ button to display a movie and press the  button.

- Images with a  icon are movies.
- You can also select images by using the control dial.



3. Use the ◀ or ▶ button to select  (Play) and press the  button.

- The movie will start playing.
- If you press the **FUNC./SET** button during playback, you can pause and restart the movie.
- You can adjust the playback volume with the ▲ or ▼ button.



Downloading Images to a Computer

We recommend using the supplied software.

Items to Prepare

- Camera and computer
- Canon Digital Camera Solution Disk supplied with the camera
- Interface cable supplied with the camera

System Requirements

Please install the software on a computer meeting the following minimum requirements.

Windows

OS		Windows Vista (including Service Pack 1) Windows XP Service Pack 2
Computer Model		The above OS should be pre-installed on computers with built-in USB ports.
CPU	Still Image	Pentium 1.3 GHz or higher
	Movie	Core2 Duo 1.66 GHz or higher
RAM	Still Image	1 GB or more
	Movie	1 GB or more
Interface		USB
Free Hard Disk Space		<ul style="list-style-type: none"> • Canon Utilities <ul style="list-style-type: none"> - ZoomBrowser EX : 200 MB or more - PhotoStitch : 40 MB or more - Digital Photo Professional : 200 MB or more
Display		1,024 × 768 pixels/High Color (16 bit) or better

Macintosh

OS		Mac OS X (v10.4 – v10.5)
Computer Model		The above OS should be pre-installed on computers with built-in USB ports.
CPU	Still Image	PowerPC G4/G5 or Intel Processor
	Movie	Core Duo 1.66 GHz or higher
RAM	Still Image	1 GB or more
	Movie	1 GB or more
Interface		USB
Free Hard Disk Space		<ul style="list-style-type: none"> • Canon Utilities - ImageBrowser : 300 MB or more - PhotoStitch : 50 MB or more - Digital Photo Professional : 200 MB or more
Display		1,024 × 768 pixels/ 32,000 Colors or better

Preparing to Download Images

1. Installing the software.

Windows

1. Place the Canon Digital Camera Solution Disk in the computer's CD-ROM drive.
2. Click [Easy Installation].

Follow the onscreen messages to proceed with the installation.



3. Click [Restart] or [Finish] once the installation is complete.

When the installation is finished, [Restart] or [Finish] will display. Click the button that appears.



4. Remove the CD-ROM from the drive when your normal desktop screen appears.

Macintosh

Double-click the  icon in the CD-ROM window. When the installer panel appears, click [Install]. Follow the onscreen instructions to proceed.



2. Connecting the camera to a computer.

1. Connect the supplied interface cable to the computer's USB port and to the camera's DIGITAL terminal.

Open the camera's terminal cover and insert the interface cable all the way into the terminal.

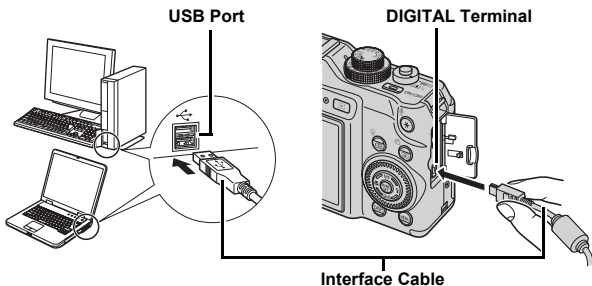

3. Preparing to download images to the computer.

1. Press the  (Playback) button to turn on the camera.

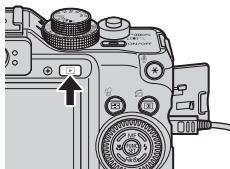

4. Open CameraWindow.

Windows

Select [Canon CameraWindow] and click [OK].

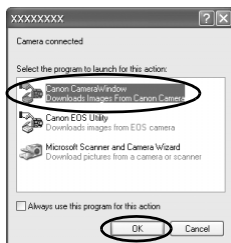

If the window above does not appear, click the [Start] menu and select [All Programs] or [Programs], followed by [Canon Utilities], [CameraWindow], [CameraWindow] and [CameraWindow].

CameraWindow appears.

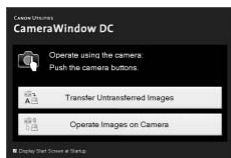

Macintosh

CameraWindow will appear when you establish a connection between the camera and computer. If it fails to appear, click the [CameraWindow] icon on the Dock (the bar which appears at the bottom of the desktop).

Preparations for downloading images are now finished. Please proceed to the *Downloading Images Using the Camera (Direct Transfer)* section (p. 31).



Refer to the *Software Starter Guide* for details on downloading images using the computer.

Downloading Images Using the Camera (Direct Transfer)

Use this method to download images using camera operations.

Install the software before downloading images via the direct transfer method for the first time (p. 28).

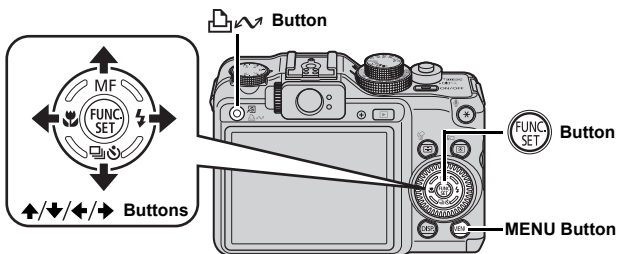

1. Confirm that the Direct Transfer menu is displayed on the camera's LCD monitor.

- The  button will light blue.
- Press the **MENU** button if the Direct Transfer menu fails to appear.

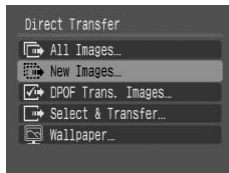





Direct Transfer Menu



2. Press the button.

- Images not previously downloaded will download to the computer.

You can also use the following options in the Direct Transfer menu to set the method for downloading images.

	All Images	Transfers and saves all images to the computer.
	New Images	Transfers and saves to the computer only the images that have not been previously transferred.
	DPOF Trans. Images	Transfers and saves to the computer only the images with DPOF Transfer Order settings.
	Select & Transfer	Transfers and saves single images to the computer as you view and select them.
	Wallpaper	Transfers and saves single images to the computer as you view and select them. The transferred images display as the background on the computer desktop.

All Images/New Images/DPOF Trans. Images

1. Use the  or  button to select ,  or  and press the  button.

- The images will download. The  button will blink blue while downloading is in progress.
- The display will return to the Direct Transfer menu when the download is complete.
- Pressing the **FUNC./SET** button will cancel a download in progress.



Select & Transfer/Wallpaper

1. Use the  or  button to select  or  and press the  button (or  button).

2. Use the ← or → button to select images to download and press the button.

- The images will download. The  button will blink blue while downloading is in progress.



3. Press the MENU button after downloading finishes.

- You will return to the Direct Transfer menu.



Only JPEG images can be downloaded as wallpaper for a computer.



The option selected with the  button is retained even when the camera's power is turned off. The previous setting will be in effect the next time the Direct Transfer menu is displayed. The image selection screen will appear directly when the [Select & Transfer] or the [Wallpaper] option was last selected.

Click  at the top right of CameraWindow, and select an application from the window that appears.

Windows

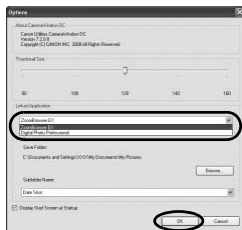

Macintosh



When you click [x] at the bottom right of CameraWindow, the selected application starts up.

By default, the downloaded images are saved into folders according to their shooting dates.

System Map

Speedlite
220EXSpeedlite
430EX II*4Speedlite
580EX II*4Speedlite
Transmitter
ST-E2High-Power
Flash HF-DC1

Supplied with Camera

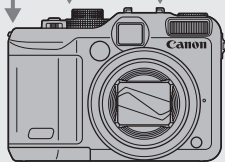
Neck Strap
NS-DC8Battery Pack
NB-7L*1
(With Terminal Cover)Battery Charger
CB-2LZ/CB-2LZE*1Interface Cable
IFC-400PCU*1AV Cable
AVC-DC300*1Canon Digital Camera
Solution Disk

AC Adapter Kit ACK-DC50

Compact Power Adapter
CA-PS700DC Coupler
DR-50

Power Cord

Soft Case
SC-DC60
seriesRemote Switch
RS60-E3Waterproof Case
WP-DC28Waterproof Case Weight
WW-DC1

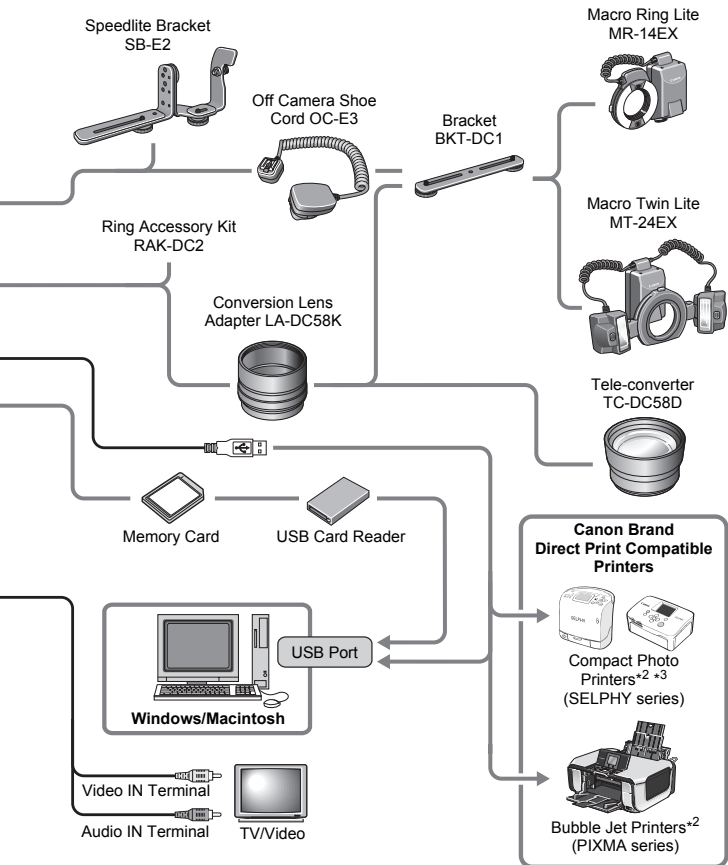

*1 Also available for purchase separately.

*2 See the user guide supplied with the printer for more information on the printer and interface cables.

*3 This camera can also be connected to the CP-10/CP-100/CP-200/CP-300.

*4 Speedlite 430EX and 580EX may also be used.

Accessories (Sold Separately)

The following camera accessories are sold separately. Some accessories are not sold in some regions, or may no longer be available.

Lenses, Lens Adapter

- **Conversion Lens Adapter LA-DC58K**

This adapter is required for mounting the Tele-converter, Macro Ring Lite or Macro Twin Lite to the camera.

- **Tele-converter TC-DC58D**

Converts the focal distance of the body lens by a factor of approximately 1.4x when attached.

Flash

- **EX-Series Speedlites**

Speedlites for Canon EOS models. Subjects are optimally illuminated for crisp, natural images.

- Speedlite 220EX/430EX II/580EX II*

* Speedlite 430EX and 580EX can also be used.

- **Speedlite Transmitter ST-E2**

This allows the wireless control of slave (remote) Speedlite flashes (except the Speedlite 220EX).

- **High-Power Flash HF-DC1**

This attachable supplementary flash can be used to capture photographic subjects that are too distant for the built-in flash to illuminate.

- **Speedlite Bracket SB-E2**

This bracket helps prevent unnatural shadows from appearing on the sides of objects when shooting from a vertical position, and is useful for shooting portraits. The Off Camera Shoe Cord OC-E3 is supplied with this bracket.

- **Off Camera Shoe Cord OC-E3**

This cord allows you to use a Speedlite up to 60 cm (2.0 ft.) away from the camera.

- **Macro Ring Lite MR-14EX / Macro Twin Lite MT-24EX**

These flashes are specially designed to allow a wider range of macro shooting with a flash.

The Conversion Lens Adapter LA-DC58K (sold separately), Off Camera Shoe Cord OC-E3 (sold separately), and Bracket BKT-DC1 (sold separately) are required to attach these flashes to the camera.

Power Supplies

- **Battery Pack NB-7L**

Rechargeable lithium-ion battery.

- **Battery Charger CB-2LZ/CB-2LZE**

A battery charger for Battery Pack NB-7L.

- **AC Adapter Kit ACK-DC50**

This is an adapter to supply power from household power outlets.

Recommended to power a camera for an extended period of time or when connecting to a computer (cannot be used to charge the camera battery).

Other Accessories

- **Interface Cable IFC-400PCU**

Use this cable to connect the camera to a computer, Compact Photo Printer (SELPHY series), or to a Bubble Jet printer*.

* Refer to your Bubble Jet printer user guide.

- **AV Cable AVC-DC300**

Use this cable to connect the camera to a TV set.

- **Waterproof Case WP-DC28**

You can use this case to take underwater shots at depths of up to 40 meters (130 feet), and of course it's ideal for taking worry-free pictures in the rain, at the beach, or on the ski slopes.

- **Soft Case SC-DC60 series**

Protects the camera from scratching and dust. Handle with care as the case's leather material may discolor.

- **Ring Accessory Kit RAK-DC2**

A set of lens rings in three different colors.

- **Remote Switch RS60-E3**

Connecting the remote switch to the camera allows you to release the shutter button without touching the camera, thereby reducing the risk of camera shake. You are recommended to shoot with the camera attached to a tripod or other device.

- **Bracket BKT-DC1**

A bracket used to attach a Macro Ring Lite or Macro Twin Lite flash to the camera.

Direct Print Compatible Printers

Canon offers the following separately sold printers for use with the camera. You can produce photo quality prints quickly and easily by connecting them to the camera with a single cable and operating the camera's controls.

- **Compact Photo Printers (SELPHY series)**
- **Bubble Jet Printers (PIXMA series)**

For more information, visit your nearest Canon retailer.

Use of genuine Canon accessories is recommended.

This product is designed to achieve excellent performance when used with genuine Canon accessories. Canon shall not be liable for any damage to this product and/or accidents such as fire, etc., caused by the malfunction of non-genuine Canon accessories (e.g., a leakage and/or explosion of a battery pack). Please note that this warranty does not apply to repairs arising out of the malfunction of non-genuine Canon accessories, although you may request such repairs on a chargeable basis.

Learning More

Components Guide

■ Front View

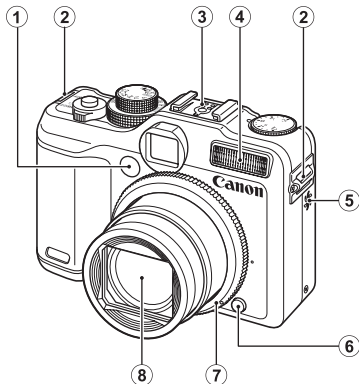

- ① Lamp (AF Assist Beam: p. 56, Red-Eye Reduction Lamp: p. 114, Self-Timer Lamp: p. 75)
- ② Strap Mount (p. 13)
- ③ Hot Shoe (p. 265)
- ④ Flash (p. 73)
- ⑤ Speaker
- ⑥ Ring Release Button (pp. 261, 264)
- ⑦ Ring (p. 264)
- ⑧ Lens



The LCD monitor may be covered with a thin plastic film for protection against scratches during shipment. If so, remove the film before using the camera.

■ Back View

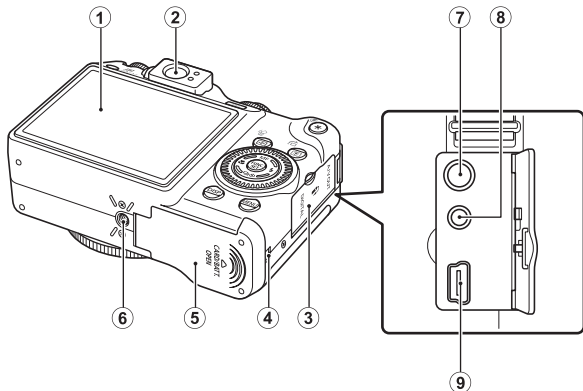

- ① Screen (LCD Monitor) (p. 63)
- ② Viewfinder
- ③ Terminal Cover
- ④ DC Coupler Cable Cover (p. 259)
- ⑤ Memory Card/Battery Cover (p. 11)
- ⑥ Tripod Socket
- ⑦ A/V OUT (Audio/Video output) Terminal (p. 228)
- ⑧ Remote Terminal (p. 274)
- ⑨ DIGITAL Terminal (pp. 21, 29)

Using the Optical Viewfinder to Shoot

Turning the LCD monitor off (p. 63) and using the optical viewfinder can help conserve power while shooting.

- You can adjust the viewfinder with the diopter adjustment dial to adapt to your vision so that the subject appears in sharp focus (p. 42). Adjustments of -3.0 to $+1.0 \text{ m}^{-1}$ (dpt) can be made.
- You may be able to see part of the lens through the viewfinder depending on the zoom setting.
- The viewfinder has a field of vision of approximately 77% of the actual shooting image.

■ Controls

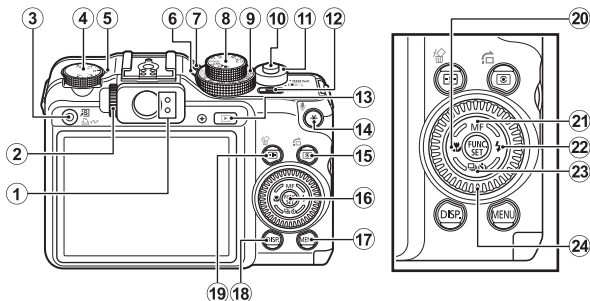

- ① Indicators (p. 45)
- ② Diopter Adjustment Dial
- ③ (Shortcut/
 (Print/Share) Button
(pp. 21, 31, 155)
- ④ Exposure Compensation Dial
(p. 137)
- ⑤ Exposure Compensation
Lamp
- ⑥ ISO Speed Lamp
- ⑦ Microphone (pp. 194, 195)
- ⑧ Mode Dial (pp. 17, 24, 90)
- ⑨ ISO Speed Dial (p. 87)
- ⑩ Shutter Button (pp. 17, 24)
- ⑪ Zoom Lever (pp. 68, 159)
Shooting: (Wide Angle)/
 (Telephoto)
Playback: (Index)/
 (Magnify)
- ⑫ Power Button/Power Lamp
- (pp. 17, 24)
- ⑬ (Playback) Button (p. 19)
- ⑭ (AE Lock/FE Lock)/
 (Microphone) Button
(pp. 134, 136, 194, 195)
- ⑮ (Metering Light)/
 (Jump) Button (pp. 141,
163)
- ⑯ **FUNC./SET** (Function/Set)
Button (p. 47)
- ⑰ **MENU** Button (p. 48)
- ⑱ **DISP.** (Display) Button (p. 63)
- ⑲ (AF Frame Selector)/
 (Single Image Erase)
Button (pp. 121, 20)
- ⑳ (Macro)/ Button (p. 74)
- ㉑ **MF** (Manual Focus)/
Button (p. 128)
- ㉒ (Flash)/ Button (p. 73)
- ㉓ (Continuous Shooting)/
 (Self-Timer)/ Button
(pp. 111, 75)
- ㉔ Control Dial (p. 43)

Using the Control Dial

Turning the control dial counterclockwise is equivalent to pressing the ◀ button, while turning the control dial clockwise is equivalent to pressing the ▶ button (it is equivalent to pressing the ▲ or ▼ button with some functions).

You can perform the following operations when you turn the control dial.



■ The Shooting Functions

- Selecting the shooting modes (pp. 24, 91, 104)
- Selecting options in ⚡/🌸/📷/🕒 (pp. 73, 74, 111, 75)
- Selecting the FUNC. menu items (p. 47)
- Selecting the shooting direction in Stitch Assist mode (p. 102)
- Selecting the shutter speed and the aperture value (pp. 96, 98)
- Moving the AF Frame (p. 123)
- Adjusting the focus in manual focus mode (p. 130)
- Program Shift (p. 135)
- Metering Mode (p. 141)

■ The Playback Functions

- Selecting an image (pp. 19, 159, 160, 163)
- Operation when setting/editing (pp. 177, 187, 194, 195, 207, 214)
- Operation when viewing/editing movies (pp. 26, 171, 173)

■ The Shooting and Playback Functions

- Selecting a menu item and making settings (pp. 47, 48, 230)
- Changing the clock display color (p. 46)
- Setting My Camera contents (p. 230)

Using the Button

The  button can turn the camera on/off and switch between the shooting/playback modes.

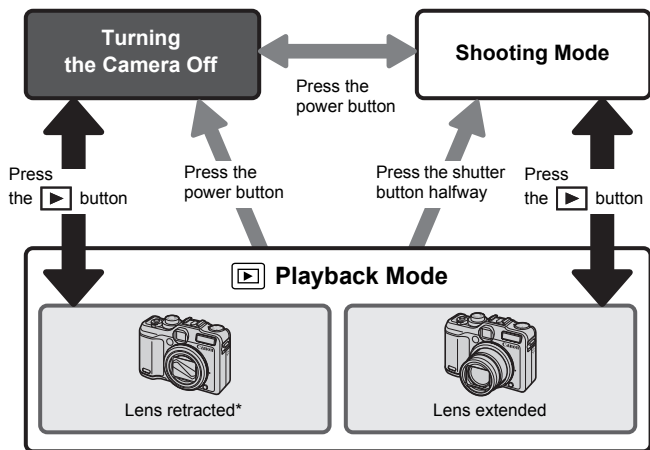
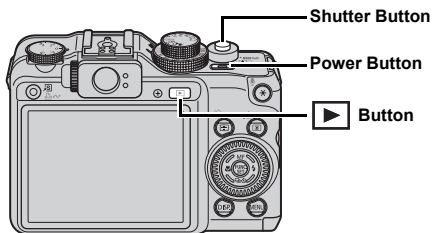

* The amount of time before the lens automatically retracts can be set in [Lens Retract] in the  (Set up) menu (p. 60).

Indicators

The indicators on the back of the camera will light or blink under the following conditions.

• Upper Indicator

- Green : Ready to shoot (camera beeps twice)/when display off
- Blinking Green : Image recording/reading/erasing/transferring (when connected to a computer/printer)
- Orange : Ready to shoot (flash on)
- Blinking Orange : Ready to shoot (camera shake warning)

• Lower Indicator

- Yellow : Macro mode/Manual focus mode/AF lock mode
- Blinking Yellow : Focusing difficulty (camera beeps once)



Never do the following while the indicator on the back blinks green. These actions may corrupt image data.

- Shake or jolt the camera
- Shut off the power, or open the memory card/battery cover

Displaying the Clock

You can display the current date and time for a 5-second* interval using the following two methods.

* Default setting.



15:08:14

- ① Hold the **FUNC./SET** button down while turning on the power.
- ② In a shooting/playback mode, hold the **FUNC./SET** button down for more than one second.

If you hold the camera horizontally, it displays the time. If you hold it vertically, the time and date display. If you use method ① to display the clock while holding the camera vertically, however, the clock will first display as if the camera were being held horizontally.

- You can change the display color by pressing the ◀ or ▶ button or turning the control dial.
- The clock display will cease when the display interval is over or when a button is operated.
- The clock's display interval can be changed in the **[[** menu (p. 60).
- The clock cannot be displayed in the magnified display or the index playback.

Basic Operations

Menus and Settings

Settings for the shooting or playback modes or such camera settings as the print settings, date/time and sounds are set using the FUNC. menu or the Rec., Play, Print, Set up, My Camera or My Menu menus.

FUNC. Menu (Button)

This menu sets many of the common shooting functions.

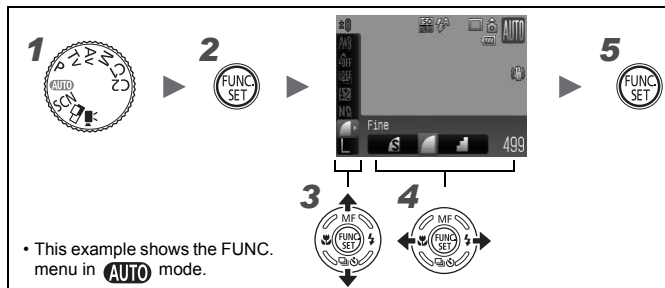

1 Set the mode dial to the shooting mode you want to use.

2 Press the  button.

3 Use the **↑** or **↓** button to select a menu item. Some items may not be selectable in some shooting modes.

4 Use the **←** or **→** button to select an option for the menu item.

- Items showing the **DISP.** icon can be changed with the **DISP.** button.
- After selecting an option, you can press the shutter button to shoot immediately. After shooting, the menu will appear again, allowing you to adjust the settings easily.
- You can also use the control dial to select an option for the menu item.

5 Press the  button.

Rec., Play, Print, Set up, My Camera and My Menu Menus (MENU Button)

Convenient settings for shooting, playback or printing can be set with these menus.

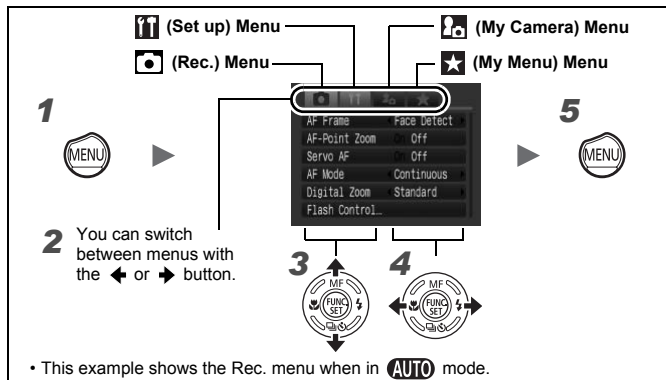

1 Press the **MENU** button.

2 Use the ← or → button to switch between menus.

- You can also use the zoom lever to switch between menus.
- The following menus are displayed.

Shooting: Rec./ Set up/ My Camera/ My Menu
 Playback: Play/ Print/ Set up/ My Camera

3 Use the ↑ or ↓ button to select a menu item.

- Some items may not be selectable in some shooting modes.
- You can also use the control dial to select a menu item.

4 Use the ← or → button to select an option.

Menu items followed by an ellipsis (...) can only be set after pressing the **FUNC./SET** button to display the next menu. Press the **FUNC./SET** button again to confirm the setting and press the **MENU** button to return the menu screen.

5 Press the **MENU** button.







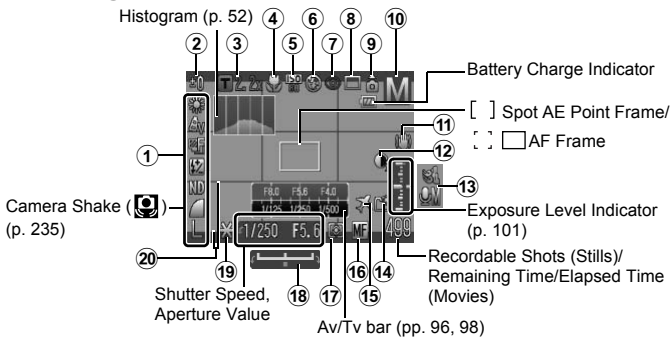















Information Displayed on the LCD Monitor and Menus

Available Shooting Modes >> p. 300

Shooting Mode





	Information Displayed	Setting Method
①	White Balance or Recording Pixels, etc.	FUNC./SET button (FUNC. menu)
②	Exposure Compensation (-2...+2)	Exposure compensation dial
③	Digital Tele-Converter (T 1.7x/2.2x)/Digital Zoom Factor/Safety Zoom (Z)	MENU button (Rec. menu), zoom lever
④	Macro (M)	button
⑤	ISO Speed (ISO AUTO HI 30 100 200 400 800 1600 3200)	ISO dial (ISO 3200 in SCN mode)
⑥	Flash (A)	button
⑦	Red-Eye Corr. (E)	MENU button ([Flash Control] menu in the Rec. menu)
⑧	Drive Mode (S, A, AF, LV, P, M, BKT, C, C)	button

	Information Displayed	Setting Method
⑨	Auto Rotate (  )	MENU button (Set up menu)
⑩	Shooting Mode	Mode dial, control dial
⑪	Image Stabilization (       )	MENU button (Rec. menu)
⑫	i-Contrast ()	MENU button (Rec. menu)
⑬	Audio ( )	MENU button (Set up menu)
⑭	Create Folder ()	MENU button (Set up menu)
⑮	Time Zone ()	MENU button (Set up menu)
⑯	Manual Focus (MF)	MF button
⑰	Metering Mode (  )	 button
⑱	Exposure Shift Bar ()	 button
⑲	AE Lock/FE Lock	 button
⑳	Display Overlays	MENU button (Rec. menu)

About the Battery Charge Indicator

- The following icons and message will display.

Display on the LCD monitor	Summary
	Sufficient battery charge.
	Recharge the battery as soon as possible if you plan on using the camera for an extended period.
 (blinking red)	Low battery charge. Recharge the battery.
Change the battery pack.	Battery is depleted and the camera can no longer operate. Charge the battery immediately.



If the indicator blinks orange and the camera shake warning icon (📷) displays, this indicates that a slow shutter speed may have been selected due to insufficient illumination. Use the following methods to shoot:



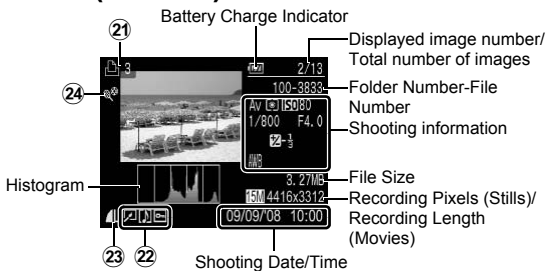

- Set the IS mode to any setting other than [Off] (p. 85)
- Raise the ISO speed (p. 87)
- Use the Auto ISO Shift (p. 88)
- Select a flash setting other than (🔴) (p. 73)
- Attach the camera to a tripod or other device

Playback Mode (Detailed)



	Information Displayed	Setting Method
21	Print List	📄 button, MENU button (Print menu)
22	(Playback) i-Contrast/Red-Eye Correction Function/Trimming/Resized image/My Colors (🎨) Protection Status (🔒)	MENU button (Play menu)
	Image with Sound Memo (🔊)	🔊 button
23	Compression (Still Images)/Recording Pixels (Still Images), Movie (MOV)	FUNC./SET button (FUNC. menu)
24	Auto Category (📁)	MENU button (Rec. menu)
	My Category (📁)	MENU button (Play menu)

The following information may also be displayed with some images.

	A sound file in a format other than the WAVE format is attached or the file format is not recognized.
	JPEG image not conforming to Design rule for Camera File System Standards (p. 279).
	AVI data type
	Unrecognized data type



- Information for images shot on other cameras may not display correctly.
- Overexposure Warning
In the following cases, overexposed portions of the image blink.
 - When reviewing an image right after shooting in the LCD monitor (information view).
 - When using the detailed display mode during playback.

Histogram Function

The histogram is a graph that allows you to check the brightness of an image. You can also display the histogram in the **P**, **Tv**, **Av** and **M** modes to check the brightness while shooting. The greater the bias toward the left in the graph, the darker the image. The greater the bias toward the right, the brighter the image. By using the exposure compensation function, you can correct the image brightness before shooting (p. 137).

Sample Histograms



Dark Image



Balanced Image



Bright Image



You can change the shutter speed, aperture value and ISO speed to adjust the brightness of an image in the **M** mode.

Shooting Mode

Menu Item	Options	Reference Page
Still Image		pp. 17, 90
Movie		pp. 24, 104

Settings using the , , MF, or button

Menu Item	Options	Reference Page
Metering Mode		p. 141
Macro		p. 74
Manual Focus	MF	p. 130
Flash		p. 73
Drive Mode		pp. 111, 75 (will also display in movie mode.)

Settings using the ISO Speed Dial or Exposure Compensation Dial

Menu Item	Options	Reference Page
ISO Speed		p. 87
Exposure Compensation		p. 137















FUNC. Menu

Menu Item	Options	Reference Page
White Balance	AWB 	p. 143
My Colors	 	p. 146
Bracket		pp. 133, 139
Flash Compensation/Flash Output		p. 113
ND Filter	ND	p. 140
Compression		p. 81
Recording Pixels (Still Image)		p. 80
Recording Pixels (Movie)		p. 107

Rec. Menu

* Default setting

Menu Item	Options	Summary/ Reference Page
AF Frame		
AUTO/SCN	Face Detect*/AiAF/Center	p. 121
P/Tv/Av/M	FlexiZone*/Face Detect/AiAF	
AF-Point Zoom	On/Off*	p. 116
Servo AF	On/Off*	p. 127
AF Mode	Continuous*/Single	p. 120
Digital Zoom		
(Still image)	Standard*/Off/1.7x/2.2x	p. 69
(Movie)	Standard*/Off (In standard movie mode only)	
Flash Control		
Flash Mode	Auto*/Manual	
Flash Exp. Comp	-2 to 0* to +2	
Flash Output	Minimum*/Medium/Maximum	
Shutter Sync.	1st-curtain*/2nd-curtain	p. 113
Slow Synchro	On/Off*	
Red-Eye Corr.	On/Off*	
Red-Eye Lamp	On*/Off	
Safety FE	On*/Off	
i-Contrast	Off*/Auto	p. 138
Drive Settings	FaceSelf-Timer: 1 – 10 (Default is 3 shots) Self-Timer: 10 sec.* , 2 sec., Custom Timer Delay: 0 – 10*, 15, 20, 30 sec. Shots: 1 – 10 (Default is 3 shots)	p. 75
Spot AE Point	Center*/AF Point	p. 142
Safety Shift	On/Off*	p. 97

Menu Item	Options	Summary/ Reference Page
Auto ISO Shift	On/Off*	p. 88
MF-Point Zoom	On*/Off	p. 130
Safety MF	On*/Off	p. 131
AF-assist Beam	On*/Off	p. 40
Review (Rec. Review)	Off/2* – 10 seconds/Hold	You can set the length of time images display after being shot (p. 18).
Review Info	Off*/Detailed/Focus Check	p. 118
Record  + 	On/Off*	p. 84
Save Original	On/Off*	p. 153
Auto Category	On*/Off	p. 154
IS Mode		
(Still image)	Continuous*/Shoot Only/ Panning/Off	p. 85
(Movie)	Continuous*/Off	
Converter	Off*/TC-DC58D	p. 263
Custom Display		
LCD/ Viewfinder	 /  / 	
Shooting info.	Off* ¹ /On* ²	p. 66
Grid Lines	Off* ¹ /On* ²	
3:2 Guide	Off* ¹ * ² /On	
Histogram	Off* ¹ /On* ²	
Set Shortcut button	 *         	p. 155
Save Settings	C1 / C2	p. 109

*1 Default setting for LCD monitor 1.

*2 Default setting for LCD monitor 2.

Play Menu 

Menu Item	Reference Page
Slide Show	p. 177
My Category	p. 165
Erase	p. 202
Protect	p. 197
i-Contrast	p. 187
Red-Eye Correction	p. 182
Trimming	p. 168
Resize	p. 192
My Colors	p. 189
Sound Recorder	p. 195
Rotate	p. 175
Transfer Order	p. 214
Resume	p. 19
Transition	p. 176

Print Menu 

Menu Item	Options	Reference Page
Print	Displays the print menu.	–
Select Image & Qty.	Configures print settings for individual images as you view them.	p. 207
Select Range	Selects a range of sequential images and makes print settings for all the images in that range.	
Select by Date	Configures print settings for images corresponding to the selected date.	
Select by Category	Configures print settings for images in the selected category.	
Select by Folder	Configures print settings for images in the selected folder.	
Select All Images	Configures print settings for all images.	
Clear All Selections	Removes all print settings from images.	
Print Settings	Sets the print style.	

Set up Menu



* Default setting

Menu Item	Options	Summary/Reference Page
Mute	On/Off*	Set to [On] to silence all operation sounds (except for when the memory card/battery cover is opened during recording).
Volume	Off/ 1 / 2*/ 3 / 4 / 5	Adjusts the volume of the start-up sound, operation sound, self-timer sound, shutter sound and playback sound. The volume cannot be adjusted if [Mute] is set to [On].
Start-up Vol.		Adjusts the volume of the start-up sound when the camera is turned on.
Operation Vol.		Adjusts the volume of the operation sound that beeps when any button other than the shutter button is pressed.
Selftimer Vol.		Adjusts the volume of the self-timer sound played 2 sec. before the shutter is released.
Shutter Volume		Adjusts the volume of the sound played when the shutter releases. The shutter sound does not play when a movie is recording.
Playback Vol.		Adjusts the volume of movie sounds, sound memos or sound recorder.
Audio		p. 108
Mic Level	Auto*/Manual	
Level	-40 – 0 dB	
Wind Filter	On/Off*	

Menu Item	Options	Summary/Reference Page
LCD Brightness	-7 to 0 * to +7	Use the ◀ or ▶ button to adjust the brightness. You can check the brightness in the LCD monitor while you are adjusting the setting.
Power Saving		
Auto Power Down	On*/Off	p. 216
Display Off	10 sec./20 sec./30 sec./1 min.* / 2 min./ 3 min.	
Time Zone	Home*/World	p. 217
Date/Time		p. 14
Clock Display	0 – 5* – 10 sec./ 20 sec./30 sec./ 1 min./2 min./3 min.	p. 46
Format		p. 16 (You can also select a low level format (p. 220).)
File Numbering	Continuous*/ Auto Reset	p. 221
Create Folder		
Create New Folder	Check mark (On)/ No check mark (Off)	p. 223
Auto Create	Off*/Daily/Monday- Sunday/Monthly (Creation time also can be set)	
Auto Rotate	On*/Off	p. 225
Distance Units	m/cm*/ ft/in	Sets the units for the Zoom bar (p. 68) and the MF indicator distance unit (p. 130).
Lens Retract	1 minute*/0 seconds	Sets the lens retraction timing when switching from shooting mode to playback mode.
Language		p. 15



Menu Item	Options	Summary/Reference Page
Video System	NTSC/PAL	p. 228
Print Method	Auto*/ 	See below.
Reset All		p. 227

Print Method

The connection method with the printer can be changed for printing. Although it is normally not necessary to change the setting, select  when borderless printing an image shot in  (Widescreen) mode on wide size paper using Canon compact photo printer SELPHY CP750/CP740/CP730/CP720/CP710/CP510. As this setting will be stored to memory even when the power is turned off, to print using an image size other than , return the mode to [Auto] (however, the connection method cannot be changed while connected to a printer).

My Camera Menu

* Default setting

Menu Item	Options	Reference Page
Theme	Selects a common theme for each My Camera settings item.	p. 230
Start-up Image	Sets the image displayed when the camera power is turned on.	
Start-up Sound	Sets the sound played when the camera power is turned on.	
Operation Sound	Sets the sound played when any button other than the shutter button is pressed.	
Selftimer Sound	Sets the sound played 2 seconds before the shutter releases in self-timer mode.	
Shutter Sound	Sets the sound played when the shutter button is pressed. (There is no shutter sound for movies.)	
My Camera Menu Contents	 (Off) / 1 * / 2 / 	

My Menu

Menu Item	Reference Page
My Menu Settings	p. 157

The LCD Monitor Display

Switching LCD Monitor Display Modes

Each press of the **DISP.** button, changes the display mode of the LCD monitor. See *Information Displayed on the LCD Monitor and Menus* for details (p. 49).

(The following are the screens that display when shooting in **AUTO** mode.)

■ **Shooting Mode** (The screens that display vary depending on the [Custom Display] settings (p. 66).)

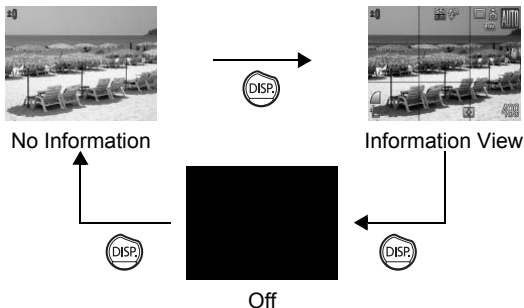

■ Playback Mode or Rec. Review (Right After Shooting)

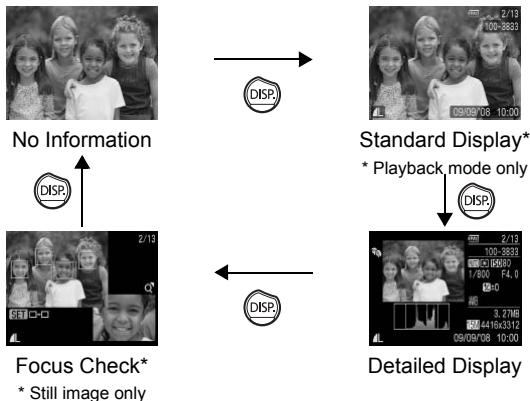

- The LCD monitor does not shut off in the **SCN** (📷, 🔋, 🔌), 📺 or 🗨 mode.
- The LCD monitor will not switch to the detailed display or focus check display in magnified display (p. 159), or index playback mode (p. 160).

LCD Monitor Brightness

The brightness of the LCD monitor can be changed in the following two ways.

- **Changing settings using the Set up menu (p. 59)**
- **Changing settings using the DISP. button (Quick-bright LCD Function)**

You can set the LCD monitor to the brightest setting regardless of the option selected in the Set up menu by pressing the **DISP.** button for more than one second*.

- To restore the previous brightness setting, press the **DISP.** button for more than one second again.
 - The next time you turn on the camera, the LCD monitor will be at the brightness setting selected in the Set up menu.
- * You cannot change the brightness of the LCD monitor with this function if you have already set it to its highest setting in the Set up menu.

Night Display



When shooting at dusk or during the evening when the dark surroundings make it difficult to view the LCD monitor, the camera's "night view" option displays the subject brightly in the LCD monitor. This will allow you to compose a shot even in dark environments (this setting cannot be turned off).

* Although noise may appear and the movement of the subject shown on the LCD monitor may appear somewhat jagged, there is no effect on the recorded image. The brightness of the image displayed in the monitor, and the brightness of the actual image recorded will be different.

Customizing Display Information

Available Shooting Modes >> p. 300

You can select which LCD monitor display modes are enabled when the **DISP.** button is pressed, as well as select which of the following information is displayed in each mode.









LCD/Viewfinder ( /  / )	Select whether to enable or disable each of the display modes for the LCD (Display 1/Display 2/No display). The display switches between each enabled display mode with each press of the DISP. button (p. 63). A display mode that is disabled will not appear when you press the DISP. button.
Shooting Info	Displays shooting information (p. 49).
Grid Lines	Displays grid lines to divide the screen into 9 parts. Helps confirm the vertical and horizontal positioning of the subject (p. 49).
3:2 Guide	Helps confirm the print area for a 3:2 print*. Areas outside the printable area are grayed out (p. 49). * Images are still recorded at the standard aspect ratio of 4:3.
Histogram	Shooting Mode: P/Tv/Av/M Displays histogram (pp. 49, 52).

1 Select [Custom Display].

1. Press the **MENU** button.
2. In the  menu, use the **↑** or **↓** button to select [Custom Display].
3. Press the  button.



2 Select [LCD/Viewfinder].

- Use the **↑**, **↓**, **←** or **→** button to select ,  or .
- Sets LCD monitor display mode after the **DISP.** button is pressed.
- If you do not wish to change the display mode, press the **DISP.** button to display  (//).
- You cannot add  to the current active LCD/Viewfinder icon.

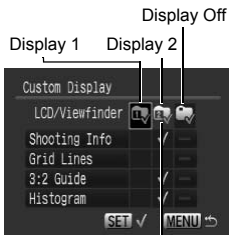

Current active display

3 Make settings.

- Use the **↑**, **↓**, **←** or **→** button to select the items you wish to display on the LCD monitor.
- Press the  button to place a ✓ mark.
- Press the **MENU** button.



Items with ✓ are displayed.

- Even though items that are grayed out can be set, they will not display in certain shooting modes.
- Display locations with no ✓ marks will not have any information displayed.



If you press the shutter button halfway and return to the shooting screen from the custom display settings screen, the settings will not be saved.

Commonly Used Shooting Functions

You can also use the control dial to select shooting modes or FUNC. menu options. See p. 43.



Using the Optical Zoom



The zoom can be adjusted from 28 – 140 mm (focal length) in 35mm film equivalent terms.

1 Press the zoom lever toward

 or .

-  Telephoto: Zooms in on the subject.
-  Wide Angle: Zooms out from the subject.

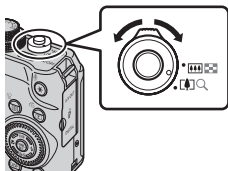

Focus range (approx.)

Zoom bar

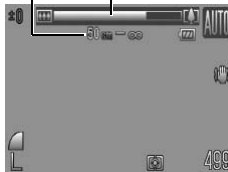

Using the Digital Zoom/ Digital Tele-Converter





Available Shooting Modes » p. 300

You can combine digital zoom with optical zoom when shooting. The available shooting characteristics and focal lengths (35mm film equivalent) are as follows.













Selection	Focal Length	Shooting Characteristics
Standard	28 – 560 mm	Enables shooting at zoom factors of up to 20x with digital and optical zoom combined.
Off	28 – 140 mm	Enables shooting without digital zoom.
1.7x	47.6 – 238 mm	Digital zoom is fixed at the selected zoom factor, and the focal length shifts to maximum telephoto.
2.2x	61.6 – 308 mm	This enables a faster shutter speed and less chance of camera shake than a shot taken at the same angle of view with [Standard] or [Off].

About the Safety Zoom

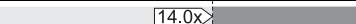
Depending on the number of recording pixels set, you can shift from optical zoom to digital zoom without pausing up to a factor where the image quality does not deteriorate (Safety Zoom).  displays when reaching the maximum zoom factor without image deterioration.

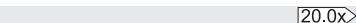
Pressing the zoom lever toward  again allows you to zoom even further (not available in ).

Depending on the number of recording pixels set, the Safety Zoom zone (factor) varies as follows (: the number is the zoom factor at which zooming pauses).

Recording pixels	Optical zoom	Digital zoom	
L	 5.0x		
M1	 6.4x		
M2	 8.5x		
M3	 14.0x		
S	 20.0x		
The color of the zoom bar	White ()	Yellow ()	Blue ()
	Zone without deterioration		Zone with deterioration



- The digital zoom cannot be used when the LCD monitor is turned off.
- The digital zoom cannot be used in **W** or **RAW** mode.

Shooting with the Digital Zoom

1 Select [Digital Zoom].

1. Press the **MENU** button.
2. In the  menu, use the **↑** or **↓** button to select [Digital Zoom].



2 Make settings.

1. Use the **←** or **→** button to select [Standard].
2. Press the **MENU** button.



3 Press the zoom lever toward and shoot.

- The combined digital and optical zoom factor will display in the LCD monitor.
- The image may appear coarse depending upon the selected recording pixels. The zoom factor appears in blue in this case.
- Press the zoom lever toward  to zoom out.

Focus range (approx.)

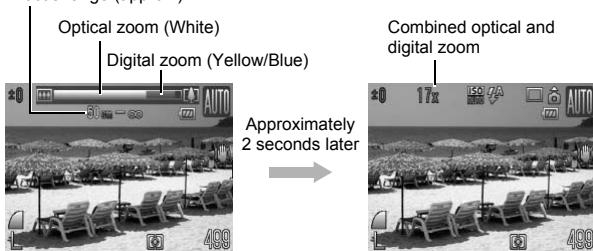

Shooting with the Digital Tele-Converter

The digital tele-converter feature uses digital zoom to achieve the effects of a tele-converter (a lens used in telephoto shooting).

1 Select [Digital Zoom].

1. Press the **MENU** button.
2. In the  menu, use the **↑** or **↓** button to select [Digital Zoom].



2 Make settings.

1. Use the **←** or **→** button to select [1.7x] or [2.2x].
2. Press the **MENU** button.

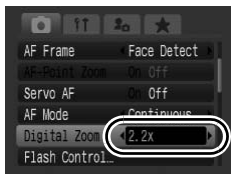

3 Adjust the zoom level with the zoom lever and shoot.

- **T** and the zoom factor appear on the LCD monitor.
- The image may appear coarse depending upon the selected recording pixels (the **T** icon and the zoom factor appear in blue).



⚡ Using the Flash



Available Shooting Modes >> p. 300

1 Press the ⚡ button.

1. Use the ◀ or ▶ button to change the flash mode.

⚡A : [Auto]

⚡ : [On]

⊕ : [Off]



- You can configure detailed settings for the flash when you press the **MENU** button while this screen is displayed (p. 113).



You are recommended to shoot with the camera attached to a tripod or other device if the camera shake warning icon  appears.

Shooting Close-ups (Macro)



Available Shooting Modes >> p. 300

Use this mode to shoot close-ups of flowers or small items. The image area at the minimum shooting distance from the end of the lens to the subject (1 cm (0.39 in.)) is 32 × 23 mm (1.26 × 0.91 in.).

1 Press the button.

1. Use the  or  button to select .

- The zoom bar will display while you adjust the zoom. The zoom bar disappears after approx. 2 seconds.

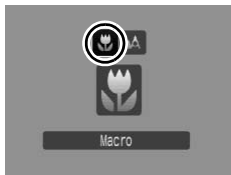

Focus range (approx.)



To Cancel the Macro Mode:

Press the  button and use the  or  button to select  (Normal).



You can decrease the size of the AF frame to make focusing on specific parts of an object easier (p. 124).







- Use the LCD monitor to compose close-ups in macro mode since images composed with the viewfinder may be off-center.
- Using the flash in macro mode may cause image edges to darken.

Using the Self-Timer



Available Shooting Modes >> p. 300

You can set the time delay and the number of shots you wish to take in advance.

 10 sec. Self-Timer	Shoots 10 seconds after you press the shutter button. <ul style="list-style-type: none"> • 2 seconds before the shutter releases, the self-timer lamp and sound speed up.
 2 sec. Self-Timer	Shoots 2 seconds after you press the shutter button. <ul style="list-style-type: none"> • When you press the shutter button, the self-timer sound beeps quickly, the lamp blinks, and the shutter releases 2 seconds later.
 Custom Timer	You can change the delay time (0 – 10, 15, 20, 30 sec.) and number of shots (1 – 10). <ul style="list-style-type: none"> • When a delay time of over 2 seconds is set for the [Delay] option, the self-timer sound beeps quickly 2 seconds before the shutter releases. If multiple shots have been specified for the [Shots] option, the sound will play for the first shot only.
 Face Self-Timer	When you press the shutter button, the camera shoots 2 seconds after a new face is detected within the composition. You can change the number of shots (1 – 10). <ul style="list-style-type: none"> • The self-timer sound beeps rapidly and the lamp blinks when a new face is detected, and the shutter releases 2 seconds later.



1 Select [Drive Settings].

1. Press the **MENU** button.
2. In the  menu, use the **↑** or **↓** button to select [Drive Settings].
3. Press the  button.



2 Make settings.

1. Use the **↑** or **↓** button to select [Self-Timer].
2. Use the **←** or **→** button to set.
3. Press the **FUNC. SET** button.
4. Press the **MENU** button.

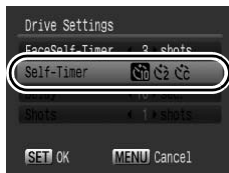

3 Press the **10** button.

1. Use the **↑** or **↓** button to select the self-timer mode.
- Pressing the **MENU** button while this screen is displayed will display the [Drive Settings] screen in Step 2.



4 Shoot.

- When you press the shutter button fully, the self-timer lamp will blink.*
- * When [Red-Eye Lamp] is set to [On] in [Flash Control] (p. 113), the lamp will light 2 seconds before the flash fires.

To Cancel the Self-Timer:

Follow Step 1 to select **■**.



Changing the Delay Time and Number of Shots (10)

1 Select [Drive Settings].

1. Press the **MENU** button.
2. In the **■** menu, use the **↑** or **↓** button to select [Drive Settings].
3. Press the **FUNC. SET** button.



2 Make settings.

1. Use the \uparrow or \downarrow to select [Self-Timer], and the \leftarrow or \rightarrow button to select .
2. Use the \uparrow or \downarrow button to select [Delay] or [Shots] and the \leftarrow or \rightarrow button to change the settings.
3. Press the  button.
4. Press the **MENU** button.

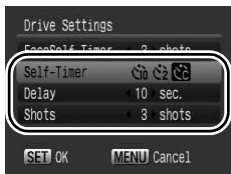



If the [Shots] option is set to 2 or more shots, the following occurs.

- The exposure and white balance are locked at the settings selected for the first shot.
- If the flash is used, the interval between shots lengthens.
- The interval between shots may lengthen when the built-in memory of the camera fills.
- Shooting will automatically cease if the memory card becomes full.







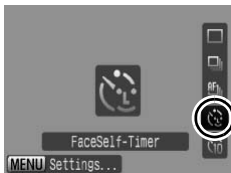

(Using the FaceSelf-Timer)

1 Select .

1. Press the  button.
2. Use the \uparrow or \downarrow button to select .



2 Set the number of shots.

1. Press the **MENU** button.
2. In the  menu, use the  or  button to select [Drive Settings].
3. Press the  button.
4. Use the  or  button to select [FaceSelf-Timer].
5. Use the  or  button to set a value.
6. Press the  button.
7. Press the **MENU** button.

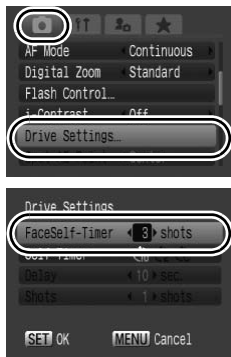

- You can set the number of shots by pressing the **MENU** button while the screen in Step 1 is displayed.

3 Compose the image and press the shutter button halfway.

- A green frame appears around the face of the main subject, while white frames appear around the other faces.

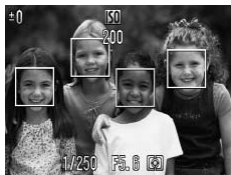

4 Press the shutter button fully to shoot.

- The camera prepares to shoot, and the “Look straight at camera to start count down” message appears.
- The self-timer lamp will blink and self-timer sound will beep.

5 Have the other subject enter the composition and face the camera.

- When the new face is detected, the blinking of the self-timer lamp and the self-timer sound speed up, and the shutter releases approx. 2 seconds later.
- When the number of shots is set to 2 or more, pictures will continue to be taken at approximately 2-second intervals.
- If the subject enters the composition but the camera does not detect the face, the shutter will release approx. 30 seconds later.



See *Face Detect Feature* (p. 122) for details on face detection.

Changing the Recording Pixels (Still Images)



Available Shooting Modes >> p. 300

1 Select the recording pixels.

1. Press the button.
2. Use the or button to select **L** and the or button to change the recording pixels.
3. Press the button.



Approximate Values for Recording Pixels

Recording Pixels				Purpose*2
L Large	15M*1	4416 × 3312	High Low	Printing to about A2 size (Approx. 420 × 594 mm (16.5 × 23.4 in.))
M1 Medium 1	9M	3456 × 2592		Printing to about A3 size (Approx. 297 × 420 mm (11.7 × 16.5 in.))
M2 Medium 2	5M	2592 × 1944		Printing to about A4 size (Approx. 210 × 297 mm (8.3 × 11.7 in.)) Printing to about Letter size prints 216 × 279 mm (8.5 × 11 in.)
M3 Medium 3	2M	1600 × 1200		Printing postcard-size prints 148 × 100 mm (6 × 4 in.) Printing L-size prints 119 × 89 mm (4.7 × 3.5 in.)
S Small	0.3M	640 × 480		Sending images as e-mail attachments or shooting more images
W Widescreen		4416 × 2480		Printing wide size prints (Images are recorded with 16:9 aspect ratios. Areas not recorded will display as black bars on the LCD monitor.)
RAW RAW		4416 × 3312		p. 82

: Approximate values for recording pixels with decimal fractions rounded off (*1 rounded up to two significant figures according to CIPA standards). M is short for megapixels.

*2 Paper sizes vary according to region.









See *Memory Cards, Estimated Capacities and Image Data Sizes (Estimated)* (p. 282).

Changing the Compression (Still Images)





Available Shooting Modes >> p. 300

1 Select a compression setting.

1. Press the  button.
2. Use the  or  button to select  and the  or  button to change the option.
3. Press the  button.



Approximate Values for Compression Settings

Compression		Purpose
 Superfine	High Quality	Shoot higher quality images.
 Fine	 Normal	Shoot normal quality images.
 Normal		Shoot more images.



See *Memory Cards, Estimated Capacities and Image Data Sizes (Estimated)* (p. 282).

Changing the Image Type



Available Shooting Modes >> p. 300

This camera records images as either JPEG images or RAW images.

JPEG image (L / M1 / M2 / M3 / S / W)

When pictures are taken as JPEG images, the images are processed inside the camera for optimum image quality, and also compressed to allow a larger number of images to be stored on the memory card. However, the compression process is irreversible, meaning that the original image data cannot be recovered once it has been compressed. See *Changing the Recording Pixels (Still Images)* and *Changing the Compression (Still Images)* (pp. 80, 81).

RAW image (RAW)

RAW data is the data output by the imaging element and converted to digital data which is recorded as is. This results in images with almost no deterioration in image quality and a higher quality than JPEG images. Using the supplied software (Digital Photo Professional), you can broadly adjust images without deterioration in image quality. Using the software's image processing functions, you can take the adjusted image data and convert it a JPEG, TIFF or other type of image in line with your intended use.

You cannot use direct print or make print (DPOF) settings with images taken with RAW, however.



When downloading RAW images and simultaneously recorded JPEG images, be sure to use the supplied software.

1 Select RAW.

1. Press the  button.
2. Use the  or  button to select  and the  or  to select .

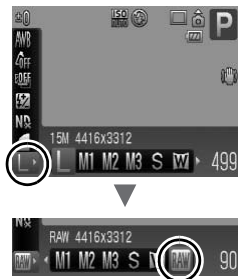

3. Press the  button.



Simultaneously Recording RAW and JPEG Images



On	Two images, a RAW image (RAW) and a JPEG image (L / Large, Fine), will be recorded with each shot. Since a L image is also recorded, you can print the image, or view it on a computer, without using the supplied software. Both images are saved with the same file number to the same folder, and can be distinguished by their file extension. RAW images end with “.CR2”, while L images end with “.JPG”.
Off	Only RAW images are recorded.

1 Select [Record RAW + L].

1. Press the **MENU** button.
2. In the  menu, use the  or  button to select [Record RAW + L].



2 Make settings.





1. Use the  or  button to select [On] or [Off].
2. Press the **MENU** button.



Setting the Image Stabilizer Function

Available Shooting Modes >> p. 300

The lens-shift type image stabilizer function allows you to minimize the camera shake effect (blurred images) when you shoot distant subjects that have been magnified or when you shoot in dark conditions without a flash.

Options	Display on the LCD monitor*	Summary
Off		—
Continuous		Since IS mode runs continuously, you can check the effect it has on image blur on the LCD monitor. This makes it easier to compose images and focus on subjects.
Shoot Only		This mode is only activated when the shutter button is pressed. When set to [Continuous], some blurring may be noticeable depending on the subjects, however in Shoot Only mode, subjects can be taken without concern for any unnatural movement that may appear on the LCD monitor.
Panning		This option only stabilizes the effect of up and down camera motions on the image. This option is recommended for shooting objects moving horizontally.

* If you are using a converter lens (sold separately) and the [Converter] setting is enabled, the icons that appear will differ (p. 263).

1 Select [IS Mode].

1. Press the **MENU** button.
2. In the  menu, use the **↑** or **↓** button to select [IS Mode].



2 Make settings.

1. Use the ◀ or ▶ button to select the image stabilizer settings.
2. Press the **MENU** button.



- Camera shake may not be fully corrected when shooting with slow shutter speeds, such as with evening shots. Use the Auto ISO Shift (p. 88), or attach the camera using a tripod to shoot. When you shoot with the camera attached to a tripod, we recommend you set [IS Mode] to [Off].
- If camera shake is too strong, it may not be fully corrected.
- Hold the camera horizontally while [Panning] (stabilization does not work when the camera is held vertically).
- If you shoot a movie after setting [IS Mode] to [Shoot Only] or [Panning], the setting will change to [Continuous].

Adjusting the ISO Speed



Available Shooting Modes >> p. 300

Raise the ISO speed to use a fast shutter speed when you wish to reduce the effects of camera shake or avoid blurry subjects, or to turn the flash off when shooting in a dark area.

1 Select an ISO Speed.

1. Select an ISO speed turning the ISO speed dial.
 - When selecting a settable ISO speed, the ISO speed lamp will light orange.
 - If you select an ISO speed that cannot be set, the ISO speed lamp turns off and the ISO speed is automatically set to (in **M** mode).
 - When you select (Auto) or (High ISO Auto), the camera sets the optimal ISO speed for the light level when shooting. As the ISO speed will automatically be raised in dark places, shutter speed will increase, reducing camera shake and subject blurring.
 - Select to put priority on image quality.
 - When you select , the camera also detects motion and sets the optimum ISO speed. As the shutter speed becomes even faster*, camera shake and blurred photos caused by subject movement will be reduced even more than when shooting the same scene in .

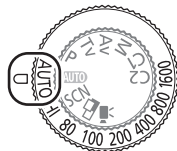

* Noise may increase in the captured image compared to ISO AUTO.





- You can set the ISO speed to (p. 94).
- The camera automatically applies noise reduction processing when you shoot at a high ISO speed.
- If the camera is set at or , the ISO speed automatically set by the camera will be displayed when pressing the shutter button halfway or in playback information.





Reducing Camera Shake When Shooting (Auto ISO Shift)





Available Shooting Modes >> p. 300

When the camera shake warning icon () appears during shooting, this function allows you to increase ISO speed and to shoot at a shutter speed which minimizes the effects of camera shake by pressing the  button.





- In , , or  mode, it will not function when the flash fires.
- Depending on shooting conditions, the camera shake warning icon () may continue to display even if the ISO speed is increased.

1 Select [Auto ISO Shift].

1. Press the **MENU** button.
2. In the  menu, use the  or  button to select [Auto ISO Shift].





2 Make settings.

1. Use the  or  button to select [On].
2. Press the **MENU** button.





3 Press the shutter button halfway.

- When  is displayed, the  button lights in blue.



4 Press and hold the shutter button halfway, then press the button.

- The ISO speed after adjustment is displayed.
- While pressing the shutter button halfway, pressing the  button again will return the ISO speed to its original condition.
- When the AE lock (p. 134) is activated after the ISO speed is raised, the ISO speed will not return to its original setting even if you release the shutter button (at this time, the  button turns off).



5 Press the shutter button fully to shoot.

Shooting Using the Mode Dial

Mode Dial

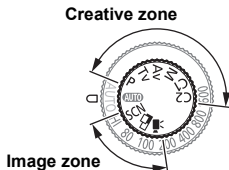

The camera automatically selects settings.

AUTO : Auto (p. 17)

■ Image zone

When a shooting mode appropriate for the shooting conditions is selected, the camera automatically adjusts settings for optimal shooting (p. 91).

SCN : Special Scene (p. 91)



: Portrait



: Night Scene



: Night Snapshot



: Indoor



: Foliage



: Beach



: Aquarium



: ISO 3200



: Color Swap



: Landscape



: Sports



: Kids&Pets



: Sunset



: Snow



: Fireworks



: Underwater



: Color Accent



: Stitch Assist (p. 102)



: Movie (pp. 24, 104)

■ Creative Zone

You can freely select camera settings such as the shutter speed and aperture value to suit your shooting purposes.

P : Program AE (p. 95)

Tv : Setting the Shutter Speed (p. 96)

Av : Setting the Aperture (p. 98)

M : Manually Setting the Shutter Speed and Aperture (p. 100)

C1, C2 : Saving Custom Settings (p. 109)

SCN Shooting Modes for Specific Scenes

Available Shooting Modes >> p. 300

When a shooting mode appropriate for the shooting conditions is selected, the camera automatically adjusts settings for optimal shooting.

1 Set the mode dial to SCN.



2 Select the scene mode.

1. Use the control dial to select the scene mode.



Portrait

Produces a soft effect when photographing people.



Landscape

Optimized for shooting landscape scenes which contain both near and far subjects.



Night Scene

Allows you to capture people against the backdrop of an evening sky or night scene. The flash is directed at the person and the shutter speed is slow, so both the person and the background can be beautifully shot. Be sure to set the flash to  before shooting.



Sports

Shoots continuous images with autofocus. Well suited for shooting moving subjects.



Night Snapshot

Allows you to take snapshots of people against twilight or night backgrounds by reducing the effects of camera shake when firmly holding the camera, even without using a tripod.



Kids&Pets

Allows you to capture subjects that move around, such as children and pets, without missing photo opportunities.



Indoor

Prevents camera shake and maintains the subject's true color when shooting under fluorescent or tungsten lighting.



Sunset

Allows you to shoot sunsets in vivid colors.



Foliage

Shoots trees and leaves - such as new growth, autumn leaves or blossoms - in vivid colors.



Snow

Shoots without a blue tinge and without making people appear dark against a snowy background.



Beach

Shoots without making people appear dark near water or sand where reflected sunlight is strong.



Fireworks

Captures fireworks in the sky sharply and at optimal exposure.



Aquarium

Selects the optimal ISO speed and white balance to capture fish and other items in an indoor aquarium.



Underwater

Appropriate for shooting images with Waterproof Case WP-DC28 (sold separately). This mode uses an optimal white balance setting to reduce bluish tones and record images with a natural hue. The flash is also reduced as much as possible for the shooting circumstances.



ISO 3200

Selects the highest possible ISO speed (3200, twice the ISO 1600 speed) and increases the shutter speed to minimize blurring of moving subjects and camera shake, even in low light conditions. Recording pixels are fixed at  (1600 × 1200).



Color Accent











Use this option to have only the color specified in the LCD monitor remain and to transform all others to black and white (p. 149).



Color Swap

Use this option to transform a color specified in the LCD monitor into another (p. 151).



- The shutter speed is slow in  or  mode. Always use a tripod to avoid camera shake.
- In , , , , , ,  or  mode, the ISO speed may increase and cause noise in the image depending on the scene being shot.
- With , image noise may be prominent.



To shoot underwater, install the camera in Waterproof Case WP-DC28 (sold separately). We recommend you use it for rain, shooting at ski resorts or beaches.

P Program AE



Available Shooting Modes >> p. 300

The camera automatically sets the shutter speed and aperture value to match the brightness of the scene. You can set the ISO speed, exposure compensation and white balance.

1 Set the mode dial to P.

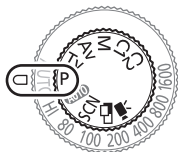

2 Shoot.



- When a correct exposure cannot be obtained, the shutter speed and aperture values are shown in red on the LCD monitor when the button is pressed halfway. Use the following shooting methods to obtain the correct exposure and make them show in white.
 - Use the flash (p. 73)
 - Adjust the ISO Speed (p. 87)
 - Use the Auto ISO Shift (p. 88)
 - Change the metering method (p. 141)
 - Set the ND filter to [On] (p. 140)
- You can change the combinations of shutter speeds and aperture values without altering the exposure (p. 135).

Tv Setting the Shutter Speed



Available Shooting Modes >> p. 300

When you set the shutter speed, the camera automatically selects an aperture value to match the brightness.

Faster shutter speeds allow you to catch an instantaneous image of a moving subject, while slower speeds create a flowing effect and allow you to shoot without a flash in dark areas.

1 Set the mode dial to Tv.



2 Configure the shutter speed.

1. Use the control dial to change the shutter speed.

- When using the control dial, the **Tv** bar will be displayed and the shutter speed can be changed.



Shutter speed
Tv bar

3 Shoot.

- If the aperture value is shown in red, the image is underexposed (insufficient light) or overexposed (too much light). Use the control dial to adjust the shutter speed until the aperture value shows in white (you can also use the Safety Shift (p. 97)).



The nature of CCDs is such that noise in the recorded image increases at slow shutter speeds. This camera, however, applies special processing to images shot at shutter speeds slower than 1.3 seconds to eliminate the noise, thereby producing high-quality images. (However, a certain amount of processing time may be required before the next image can be shot.)



- The shutter speed, zoom and aperture value have the following relationship.

	Aperture Value	Shutter Speed (seconds)
Maximum Wide Angle	f/2.8 – 3.5	15 – 1/2000
	f/4.0 – 5.0	15 – 1/2500
	f/5.6 – 8.0	15 – 1/4000
Maximum Telephoto	f/4.5 – 5.6	15 – 1/2000
	f/6.3 – 8.0	15 – 1/2500

- The fastest shutter speed for flash synchronization is 1/500 second*. Therefore, even if the shutter speed is preset to a speed higher than 1/500 second, the camera automatically resets the shutter speed to 1/500 second during shooting.

* When using an external flash, see pp. 266, 267.

Shutter Speed Display

- The following shutter speeds can be set. 1/160 indicates 1/160 second. Also, 0"3 indicates 0.3 second and 2" indicates 2 seconds.

15" 13" 10" 8" 6" 5" 4" 3" 2" 2"5 2" 1"6 1"3 1" 0"8 0"6 0"5 0"4 0"3
 1/4 1/5 1/6 1/8 1/10 1/13 1/15 1/20 1/25 1/30 1/40 1/50 1/60
 1/80 1/100 1/125 1/160 1/200 1/250 1/320 1/400 1/500 1/640
 1/800 1/1000 1/1250 1/1600 1/2000 1/2500 1/3200 1/4000

- You can change the combinations of shutter speeds and aperture values without altering the exposure (p. 135).

Safety Shift

With **Tv** and **Av** modes, if [Safety Shift] is turned [On] (p. 55) in the  menu, the shutter speed or aperture value is automatically adjusted for the correct exposure when it cannot be otherwise obtained. Safety Shift is disabled when the flash is enabled.

Av Setting the Aperture



Available Shooting Modes >> p. 300

The aperture adjusts the amount of light entering through the lens. When you set the aperture value, the camera automatically selects a shutter speed to match the brightness.

Selecting a lower aperture value (opening the aperture) allows you to blur the background and create a beautiful portrait.

A higher aperture value (closing the aperture) brings the entire range from foreground to background into focus. The larger the aperture value, the greater the range of the image brought into clear focus.

1 Set the mode dial to Av.

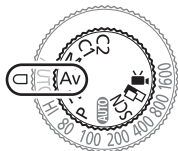

2 Configure the aperture setting.

1. Use the control dial to change the aperture value.

- When using the control dial, the **Av** bar will be displayed and the aperture value can be changed.

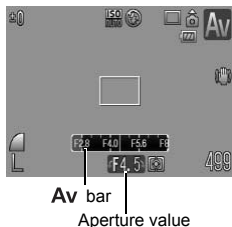

3 Shoot.

- If the shutter speed is shown in red when the shutter button is pressed halfway, the image is underexposed (insufficient light) or overexposed (too much light). Use the control dial to adjust the aperture value until the shutter speed shows in white (you can also use the Safety Shift (p. 97)).



Some aperture values may not be available with certain zoom positions (p. 97).



- The maximum shutter speed with synchronized flash is 1/500 second*. Therefore, even if an aperture value is preset, the aperture value may automatically be reset to match the synchronized flash speed.

* When using an external flash, see p. 266, 267.

Aperture Value Display

- The larger the aperture value, the smaller the lens opening, allowing less light to enter the camera.

F2.8 F3.2 F3.5 F4.0 F4.5 F5.0 F5.6 F6.3 F7.1 F8.0

- You can change the combinations of aperture values and shutter speeds without altering the exposure (p. 135).

M Manually Setting the Shutter Speed and Aperture



Available Shooting Modes >> p. 300

You can manually set the shutter speed and aperture to shoot images.

1 Set the mode dial to M.

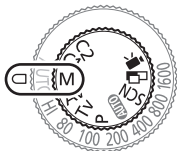

2 Configure the shutter speed and aperture setting.

1. Press the  button to select the shutter speed or aperture value.
 2. Use the control dial to change the shutter speed or aperture value.
- When using the control dial, the **Tv** bar or **Av** bar will be displayed and the aperture value can be changed.

3 Shoot.

- The current exposure level appears on the right side of the exposure level indicator, while the correct exposure level appears in the center on the left side of the indicator (if the difference is more than ± 2 stops, the current exposure level appears in red on the LCD monitor).
- When you press the shutter button halfway, the difference between the correct exposure* and the selected exposure appears on the LCD monitor. If the difference is more than ± 2 stops, “-2” or “+2” appears in red.

* The correct exposure is calculated by measuring the brightness according to the selected metering method.

- When you press the **✳** button, the shutter speed or aperture value will automatically shift to obtain the correct exposure (except when the **MF** icon and **☑** icon are selected). When the shutter speed is selected, the aperture value will change. When the aperture is selected, the shutter speed will change. In addition, if you press the **✳** button after you adjusted the exposure compensation (p. 137), the exposure will shift to the adjusted value. The exposure compensation value appears as a green line on the exposure level indicator.

Current Exposure Level



Correct Exposure Level

Exposure Level Indicator

Exposure compensation value (green line)



- If the zoom is adjusted after these values are set, the aperture value or the shutter speed may change in accordance with the zoom position (p. 97).
- The brightness of the LCD monitor matches the selected shutter speed and aperture value. When you select a fast shutter speed or shoot a subject in a dark place, set the flash to **⚡** (Flash on) or attach an externally mounted flash, the image will always be bright.

Shooting Panoramic Images (Stitch Assist)



Available Shooting Modes >> p. 300

Stitch Assist can be used to shoot overlapping images that can later be merged (stitched) to create one panoramic image on a computer.



The overlapping seams of several adjacent images can be joined into a single panoramic image.



1 Set the mode dial to .

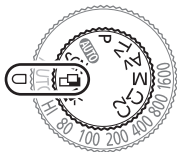

2 Select the shooting direction.

1. Use the control dial to select a shooting direction.

You can select from the following five shooting directions.

- → Left to right horizontally
- ← Right to left horizontally
- ↑ Bottom to top vertically
- ↓ Top to bottom vertically
- Clockwise starting at the top left shooting 4 images.



3 Shoot the first frame of the sequence.

- The exposure and white balance are set and locked with the first image.



4 Compose the second image so that it overlaps a portion of the first and shoot.

- You can press the ↑, ↓, ← or → button to return to the previously recorded image to retake the shot (When shooting clockwise, you can retake the entire image.).
- Minor discrepancies in the overlapping portions can be corrected when the images are stitched together.

5 Repeat the procedure for additional images.

- A sequence may contain up to 26 images (except when shooting clockwise).

6 Press the button after the last shot.



- You cannot display the images on a TV when shooting in Stitch Assist mode.
- The settings for the first image are applied to the second image onward.



Use PhotoStitch, a supplied software program, to merge the images on a computer.



Movie Shooting



Available Shooting Modes >> p. 300

The maximum size for a single movie is 4 GB*, and shooting will continue until your memory card is full. Actual maximum recording times vary depending on your memory card (p. 283).

The following movie modes are available.

 Standard	The digital zoom can (p. 71) be used while shooting in this mode.	p. 24
 Color Accent	You can have only the specified color remain and change all others into black and white.	p. 149
 Color Swap	You can change the specified color into a different color.	p. 151



* Even if the file size has not reached 4 GB, the recording stops when the recording time reaches one hour. Depending on memory card capacity and data write speed, recording may stop before the file size reaches 4 GB or the recording time reaches one hour.

1 Set the mode dial to .



2 Select a movie mode.

1. Use the control dial to select a movie mode.

- See *Changing Colors* (p. 148) for the procedures for using  and .



3 Shoot.

- Pressing the shutter button halfway automatically sets the exposure, focus and white balance settings.
- Pressing the shutter button fully starts recording video and sound simultaneously.
- During shooting, the recording time and [●Rec] appear on the LCD monitor.
- Pressing the shutter button fully again stops recording. Recording will stop automatically under the following circumstances.
 - When the maximum recording time or maximum recording capacity is reached
 - When the built-in memory or memory card becomes full





- You are recommended to use a memory card that has been formatted in your camera to shoot movies (pp. 16, 220).
- Be careful of the following while recording.
 - Try not to touch the microphone (p. 42).
 - If you press a button, the sound of the button being pressed will also be recorded.
 - The camera will automatically adjust the exposure and white balance to suit the shooting conditions during recording. Please note, however, that the sounds made by the camera while automatically adjusting the exposure may also be recorded.
- The focus and optical zoom settings remain fixed for subsequent frames at the values selected for the first frame.









- Adjust the zoom setting before shooting. The combined digital and optical zoom factor will display on the LCD monitor. When the zoom factor displays in blue, the image will deteriorate.
- You can perform the following operations before shooting the movie.
 - AF lock: If you press the **MF** button, auto focus will be fixed at the current state. The **MF** icon and MF indicator appear on the LCD monitor, and you can confirm the distance between the subject and lens. You can cancel by pressing the **MF** button again.
 - Manual focus (p. 130)
 - AE lock and exposure shift: this is effective on ski slopes and the beach when the contrast is too strong between the subject and background or where there are both light and dark areas in the scene and it is desirable to adjust the exposure.
 - 1 Press the ***** button.
The exposure will lock (AE lock) and the exposure shift bar will appear in the LCD monitor.
 2. Use the control dial to adjust the exposure.
Press the ***** button again to release the setting. Also, the setting will be canceled if you press the **MENU** button or change the white balance, My Colors or shooting mode settings.

Changing Movie Recording Pixels

	Recording Pixels	Frame Rates
	640 × 480	30 frames/sec.
	320 × 240	30 frames/sec.

1 Select the recording pixels.

1. Press the  button.
2. Use the  or  button to select  and the  or  button to change the option.
3. Press the  button.



- See *Memory Cards, Estimated Capacities and Image Data Sizes (Estimated)* (p. 282).
- Frame rates indicate the number of frames recorded or played back each second.



Setting the Recording Functions



Available Shooting Modes >> p. 300

The microphone level (sound recording level) of the movie, sound memos (p. 194) and sound recorder (p. 195) and wind filter setting (p. 195) can be changed.

1 Select [Audio].

1. Press the **MENU** button.
2. Use the **←** or **→** button to select the  menu.
3. Use the **↑** or **↓** button to select [Audio].
4. Press the  button.



2 Set the microphone level.

1. Use the **↑** or **↓** button to select [Mic Level].
2. Use the **←** or **→** button to select [Auto] or [Manual].

- When in [Manual] mode, press the **↓** button, then set the sound recording level (recording volume) with the **←** or **→** button.  displays in the LCD monitor.



3 Set the wind filter.

1. Use the **↑** or **↓** button to select [Wind Filter].
2. Use the **←** or **→** button to select [On] or [Off].
3. Press the **MENU** button.

- Recommended to set to [On] when the wind is strong.
- When set to [On],  displays in the LCD monitor.





- When in [Auto] mode, if the recording volume becomes too loud, it automatically prevents distortion of sound.
- Wind filter suppresses noise when the wind is strong. However, unnatural sound will result when used to record in locations with no wind.

C Saving Custom Settings



Available Shooting Modes >> p. 300

You can save frequently used shooting modes and various shooting settings to the **C** (Custom) mode. When necessary, you can then shoot images with previously saved settings by simply turning the mode dial to **C1** or **C2**. Settings that are not retained when the shooting mode is changed or when the power is turned off (such as continuous shooting or self-timer) are also retained.

1 Switch to the shooting mode you wish to save and make the settings.

- Functions which can be saved in **C1** or **C2**.
 - Shooting mode (**P**, **Tv**, **Av**, **M**)
 - Items which can be set in **P**, **Tv**, **Av** and **M** modes (pp. 95 – 101)
 - Rec. menu settings
 - Zoom location
 - Manual focus location
 - My Menu settings
- To change some of the settings saved in **C1** or **C2** (other than shooting mode), select **C1** or **C2**, and set again.

2 Select [Save Settings].

1. Press the **MENU** button.
2. In the  menu, use the **↑** or **↓** button to select [Save Settings].
3. Press the  button.

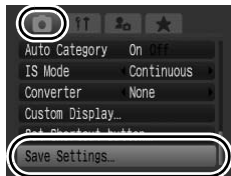

3 Register.

1. Use the ◀ or ▶ button to select [C1] or [C2].
2. Press the  button.
3. Press the **MENU** button.



- The ISO speed setting and the exposure compensation cannot be saved. When shooting with **C1/C2**, set the ISO speed with the ISO speed dial and the exposure compensation with the exposure compensation dial.
- The setting contents do not influence other shooting modes.
- Saved settings can be reset (p. 227).



Various Shooting Methods

You can also use the control dial to select shooting modes or FUNC. menu options. See p. 43.

Continuous Shooting

Available Shooting Modes >> p. 300

The camera shoots continuously while the shutter button is held down.

			Focus while shooting	Display on the LCD monitor
	Continuous Approx. 1.3 images/sec.	You can shoot continuously at a short shooting interval.	Fixed*	Recorded image
	Continuous Shooting AF Approx. 0.7 images/sec.	The camera will continue to record successive images and focus while the shutter button is held down (except in manual focus mode).	Auto focus	Subject right before shooting
	Continuous Shooting LV (Live View) Approx. 0.7 images/sec.	You can shoot continuously with a manually set focus position while confirming the subject.	Fixed*	Subject right before shooting

* The focus position of first image is fixed.

1 Press the button.

1. Use the  or  button to select

,  or .











2 Shoot.

- The camera will continue to record successive images while the shutter button is held down.
Recording will cease when the shutter button is released.

To Cancel Continuous Shooting:

Follow procedure 1 to select .



- When in ,  will be the default setting.  cannot be set.
- In  and manual focus modes,  will not display ( can be selected).
- AF frame will be set to [Center] in  mode (p. 121).
- Rec. Review (p. 18) will not be displayed in  and  modes.
- Cannot be set while in the focus bracketing shooting mode or AEB shooting mode.



- The interval between shots lengthens when the built-in memory of the camera fills.
- If the built-in flash is used, the interval between shots lengthens because the flash must charge.

Setting the Flash



Available Shooting Modes >> p. 300

You can make detailed built-in flash and external flash* settings to fit the shooting conditions.

* See *Setting the Externally Mounted Flash* (p. 268).

Built-in Flash Settings

Menu Item	Summary	Note
Flash Mode	When set to [Manual], you can control the flash output in the Tv or Av shooting mode.	–
Flash Exp. Comp	Flash exposure compensation can be adjusted in the range of –2 to +2 stops in 1/3-stop increments. You can combine the flash exposure compensation with the camera's exposure compensation function for balanced exposure of the background when shooting with a flash.	In Tv or Av shooting mode, set [Flash Mode] to [Auto] in advance.
Flash Output	The flash output can be controlled in three steps, up to FULL, when shooting.	In Tv or Av shooting mode, please set [Flash Mode] to [Manual].
Shutter Sync.	You can switch the timing at which the flash fires.	–
1st-curtain	The flash fires right after the shutter opens, regardless of the shutter speed. Usually, the 1st-curtain is used when shooting.	
2nd-curtain	The flash fires right before the shutter closes. Compared with the 1st-curtain, the flash fires later and allows you to shoot images in which, for example, a car's taillights seem to trail off behind.	

Menu Item	Summary	Note
Slow Synchro	The flash timing is adjusted to slow shutter speeds. This reduces the chance that only the background will appear dark when a night scene or an interior shot is taken.	Using Slow Synchro increases the chances for camera shake. Use of a tripod is recommended.
Red-Eye Corr.	Automatically searches for and corrects red eyes in the image when the flash fires.	—
Red-Eye Lamp	This feature reduces the effect of light reflecting back from the eyes and making them appear red.	The red-eye reduction lamp lights green before the flash fires.
Safety FE	The camera automatically changes the shutter speed or aperture value when the flash fires to avoid overexposing and blowing out the highlights in the scene.	In Tv or Av shooting mode, set [Flash Mode] to [Auto] in advance.



About Red-Eye Correction

- When [Red-Eye Corr.] is set to [On], only the corrected image is recorded to the memory card.
- If the area around the eyes is red, for example from using red eye shadow, that area may also be corrected. If this happens, set [Red-Eye Corr.] to [Off].
- Red eyes may not be automatically detected or may not be fully corrected on some images. In either case, you can correct images with [Red-Eye Correction] in the menu (p. 182).

Displaying and Setting [Flash Control]





1 Select [Flash Control].

1. Press the **MENU** button.
2. In the  menu, use the  or  button to select [Flash Control].
3. Press the  button.



- [Flash Control] can also be displayed by the following methods.
 - Press the  button for more than one second.
 - When changing the flash mode, press the **MENU** button (p. 73).

2 Make settings.

1. Use the  or  button to select the option.
2. Use the  or  button to make the setting.
3. Press the **MENU** button.

Example in Av mode



3 Press the **MENU** button.



You can also set [Flash Exp. Comp] and [Flash Output] in the FUNC. menu (p. 54).

Checking the Focus and People's Expressions



Available Shooting Modes >> p. 300

You can zoom the display of the AF frame to check focus when shooting or right after taking a shot.

Zooming the AF Frame and Shooting

When [AF Frame] is set to other than [AiAF], the AF frame area can be zoomed to check focus while shooting. When you want to capture people's expressions, set [AF Frame] to [Face Detect]. When you want to check the focus while shooting in macro mode, set [AF Frame] to [Center] or [FlexiZone].

1 Select [AF-Point Zoom].

1. Press the **MENU** button.
2. In the  menu, use the **↑** or **↓** button to select [AF-Point Zoom].



2 Make settings.

1. Use the **←** or **→** button to select [On].
2. Press the **MENU** button.



3 Press the shutter button halfway.

- Pressing the shutter button halfway zooms a section of the display according to the following AF Frame mode settings (p. 121).

[Face Detect] : The face detected as the main subject will appear zoomed.

[Center] : The center of the image will appear zoomed in the LCD monitor.

[FlexiZone] : The area within the AF frame will appear zoomed.

4 Press the shutter button fully to shoot.





The AF frame cannot be zoomed under the following circumstances:

- When [AF Frame] is set to [Face Detect] and a face is not detected, or when the face is extremely large in relation to the overall composition.
- When the camera cannot focus.
- When the digital zoom is in use.
- When a TV is being used as the display.
- When [Servo AF] (p. 127) is set to [On].

Checking Focus Right After Shooting (Focus Check)



Allows you to check the focus of an image taken. It is also easy to check people's expressions and look for closed eyes when shooting because a frame the size of the face displays when Face Select and Track (p. 121) or AF frame mode is set to [Face Detect] (p. 121). You are recommended to set [Review] to [Hold] in the  menu in advance.

1 Select [Review Info].

1. Press the **MENU** button.
2. In the  menu, use the  or  button to select [Review Info].



2 Make settings.

1. Use the  or  button to select [Focus Check].
2. Press the **MENU** button.



3 Shoot.

- The recorded image will be displayed.

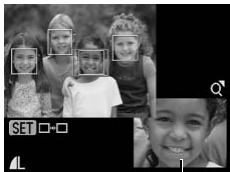

Orange frame contents

- Frames are displayed as follows.

Frame color	Content
Orange	Displays the area of the image shown at the bottom right.
White	Indicates the AF frames or the positions of faces that were used for focusing when shooting.

- The orange frame can be shown at a different magnification, moved or switched to a different frame (p. 162).

To Cancel the Focus Check:

Press the shutter button halfway.



- Pressing the  button while the image is displayed will erase the image (p. 20).
- You can check the focus even during playback mode (p. 161).

Switching between Focus Settings



Available Shooting Modes >> p. 300

You can set the AF mode.

Continuous	The camera is continually focusing on whatever it is aimed at even when the shutter button is not pressed, allowing you to shoot without missing opportunities.
Single	The camera only focuses when the shutter button is pressed halfway, conserving battery power.

1 Select [AF Mode].

1. Press the **MENU** button.
2. In the  menu, use the **↑** or **↓** button to select [AF Mode].



2 Make settings.

1. Use the **←** or **→** button to select AF mode.
2. Press the **MENU** button.







This will be set when the AF frame mode is set to [Face Detect], [FlexiZone] or [Center]. This will be fixed to [Single] when the AF frame mode is set to [AiAF] (p. 121).





Selecting an AF Frame Mode

Available Shooting Modes >> p. 300

The AF frame indicates the area of the composition on which the camera focuses.

	Face Detect	The camera detects a face and sets the focus, exposure* ¹ and white balance* ² . In addition, the camera meters the subject so that the face is correctly illuminated when the flash fires. *1 Only in evaluative metering mode (p. 141) *2 Only in  (p. 143)
	AiAF	The camera automatically selects between 9 AF frames to focus on according to the shooting conditions. You can change the AF frame size (p. 124).
	Center	The AF frame will be fixed to center. This is recommended when the target subject is at the center of the composition.
	FlexiZone	The AF frame can be moved manually to the desired area (FlexiZone). This is convenient for making sure the focus is exactly where you want it. You can change the AF frame size (p. 124).

1 Select an AF frame mode.

- Press the  button.
- Press the  button to select an AF frame mode.
 - The AF frame mode changes with each press of the button.
- Press the  button.
 - You can also select the AF frame mode in [AF Frame] in the  menu (p. 55).
 - See *Changing the AF Frame Size* (p. 124).
 - See *Moving the AF Frame* (p. 123).

Example when [AiAF] is selected

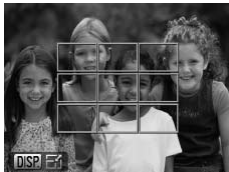



- If the LCD monitor display is turned off, the focus setting will change as follows (only [AiAF] and [Center] are available).
 - [Face Detect] will change to [AiAF].
 - [FlexiZone] will change to [Center].
- The AF frame appears as follows when the shutter button is pressed halfway.
 - Green: In focus
 - Yellow: Focusing difficulty ([Center] or [FlexiZone] option)
 - No AF frame: Focusing difficulty ([Face Detect] or [AiAF] option)

Face Detect Feature

- When the camera detects faces, AF frames will be displayed on a maximum of three faces. At this point, the frame the camera judges to be the main subject appears in white while the others appear in gray. When the shutter button is pressed halfway and the camera focuses, up to 9 green AF frames may appear. You can also select the person you wish to focus on (p. 125).
- If the white frame fails to appear and only gray frames appear, or if a face is not detected, the focusing method will change as follows.
 - When [Single] is selected, images will be shot in [AiAF] mode. (When [Servo AF] is set to [On], images will be shot in [Center] mode.)
 - When [Continuous] is selected, images will be shot in [Center] mode.
- The camera may mistakenly identify non-human subjects as a face.
- In certain cases, faces may not be detected.
Examples:
 - If faces are at the edge of the screen, or appear extremely small, large, dark or bright, relative to the overall composition.
 - Faces turned to the side or at a diagonal, or faces with a portion hidden.





Moving the AF Frame ([AiAF] or [FlexiZone] Selected)

The AF frame can be moved manually allowing you to focus precisely on the desired area of your subject. You can move the AF frame when [AiAF] is selected as the metering mode and the AF frame is set to small.

1 Press the button.

- The AF frame will display in green.

2 Move the AF frame using the control dial and press the button.

- You can move the AF frame to the position you wish to set using the , ,  or  button.
- The AF frame will move back to its original position (center), if you hold down the  button.
- When the camera detects faces selecting [AiAF], each press of the **MENU** button moves the AF frame to a different face position.



- When the [Spot AE Point] is selected as the metering mode, you can use the selected Spot AE Point as the AF frame (p. 141).
- Selection cannot be made while in the manual focus mode (p. 130).
- If you turn off the camera or the lens retracts in playback mode (p. 44), the AF frame returns to the center position.

Changing the AF Frame Size ([AiAF] or [FlexiZone] selected)

You can change the size of the AF frame to match the size of the subject. When the subject you are aiming at is small, or when you want to focus on a particular area of the subject, you can restrict the area that is focused on by making the AF frame smaller.

1 Press the button.

- The AF frame will display in green.

2 Press the **DISP.** button.

- Each time you press the **DISP.** button, the AF frame settings will switch between normal and small.
- When the camera has difficulty focusing on the subject when you press the shutter button halfway, the AF frame will display in yellow.
- Pressing the  button (or the **FUNC./SET** button) completes the setting.
- When you set the AF frame to small in AiAF mode, the LCD monitor display will appear as shown right.

Examples:

When [AiAF] is selected

Normal



Small



The AF frame size is set to normal when the digital zoom, digital tele-converter or manual focus is used.

Selecting a Subject to Focus On (Face Select and Track)



Available Shooting Modes >> p. 300

Once the focus is fixed to a subject's face, the frame can be set to follow the subject within a certain range. The AF frame mode is set to [Face Detect] in advance (p. 121).

1 Select a face to focus on.

1. Press the button while faces are detected by the camera.

- The camera enters face select mode, and the face frame () of the main subject displays in white. Even if the subject moves, the frame will follow the subject within a certain range.
- The face frame will not display when a face is not detected.



2. Select the person you wish to focus on.



- When several faces have been detected, pressing the or button or turning the control dial will move the face frame to another subject.
- Holding down the **DISP.** button for more than 1 second will display face frames (up to 35) of all the detected faces (green: face of main subject, white: detected faces).



3. Press the button again.

- The camera exits face designation mode, and the face frame () of the main subject will change to white (the frame will continue to follow the subject within a certain range).
- Pressing the button will release the face designation mode.

2 Press the shutter button halfway.

- The face frame () of main subject will change into .
- If the camera has difficulty focusing, the face frame will display in yellow.

3 Press the shutter button all the way to shoot.



In the following cases, the face select mode will be canceled.

- When turning the power back on
- When switching to another shooting mode
- When using the digital zoom or digital tele-converter
- When the **MENU** button is pressed to display the menu
- When a selected face cannot be tracked for several seconds
- When the display is turned off

Shooting with Servo AF



Available Shooting Modes >> p. 300

With Servo AF, the focus remains on a subject for as long as the shutter button is pressed halfway, so you do not miss opportunities to capture a moving subject.

1 Select [Servo AF].

1. Press the **MENU** button.
2. In the  menu, use the **↑** or **↓** button to select [Servo AF].



2 Make settings.

1. Use the **←** or **→** button to select [On].
2. Press the **MENU** button.



3 Press the shutter button halfway.

- [Face Detect]: Focus remains on the main subject marked with the blue AF frame for as long as the shutter button is pressed halfway.
- [Center], [FlexiZone]: Focus remains on the blue AF frame for as long as the shutter button is pressed halfway.

4 Press the shutter button all the way to shoot.



This option is not available in the following situations.

- When AF frame mode is set to [AiAF]
- When  is selected
- When MF is set

Shooting Hard-to-Focus Subjects

(Focus Lock, AF Lock, Manual Focus, Safety MF)



Available Shooting Modes >> p. 300

It may be difficult to focus on the following types of subjects.

- Subjects with extremely low contrast to the surroundings
- Scenes with a mixture of near and far subjects
- Subjects with extremely bright objects at the center of the composition
- Subjects that are moving quickly
- Subjects through glass

Shooting with the Focus Lock

- 1** Aim the camera so that an object at the same focal distance as the main subject is centered in the viewfinder or in the AF frame displayed on the LCD monitor.
- 2** Keep the shutter button pressed halfway while you recompose the image.
- 3** Press the shutter button fully to shoot the image.

Shooting with the AF Lock

- 1** Turn on the LCD monitor.
- 2** Aim the camera so that an object at the same focal distance as the main subject is centered in the AF frame.

3 Press and hold the shutter button halfway and press the MF button.

-  and MF Indicator will be displayed to confirm the distance from the subject.

4 Re-aim the camera to compose the shot as desired and shoot.





To Release the AF Lock:

Press the **MF** button.



When [Servo AF] (p. 127) is set to [On], AF lock cannot be used.





- In  mode, you cannot enable AF lock using the method on p. 128. Instead, you can use AF lock by registering  to [Set Shortcut button] (p. 155).
- The AF frame does not appear in the  and  modes, so be sure to point the camera at the subject on which you want to focus.
- When shooting with focus lock or AF lock using the LCD monitor, you can simplify shooting by setting [AF Frame] to [FlexiZone] or [Center] (p. 121) so that only one AF frame is active.
- The AF lock is convenient because you can let go of the shutter button to compose the image. Moreover, the AF lock is still effective after the picture is taken, allowing you to capture a second image with the same focus.
- When you shoot a subject through glass, try to shoot as close to the glass as possible to reduce the chances of light reflecting back off the glass.

Shooting in Manual Focus Mode



The focus can be manually set.

1 Turn on the LCD monitor.

2 Press the MF button to display **MF**.

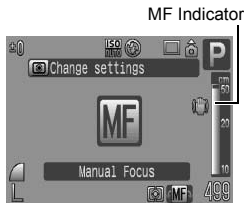
- The MF indicator is displayed.
- When the  menu's [MF-Point Zoom] is set to [On], the portion of the image in the AF frame will appear magnified*. When the AF mode (p. 120) is set to [Continuous], turning the control dial will display the portion magnified. The magnified position will differ depending on the AF Frame Mode (p. 121) setting.
 - When set to [FlexiZone], the location of the AF frame displayed immediately prior to setting the manual focus will display magnified.
 - When set to other than [AiAF], the center of the LCD monitor is magnified.
- * Can also be set so that the image displayed is not magnified (p. 56). Also when using , digital zoom, Digital Tele-Converter or while displaying the image on a TV, the display magnification is not available.
- With each press of the , the settings that can be configured with the control dial in each shooting mode will change as follows.



SCN	SCN mode/ MF
	 mode/ MF
P	Metering mode/ MF
Tv	Shutter speed/Metering mode/ MF
Av	Aperture value/Metering mode/ MF
M	Shutter speed/Aperture value/Metering mode/ MF

3 Use the control dial and adjust the focus.

- The MF indicator shows approximate figures. Use them as a shooting guideline only.

To Cancel the Manual Focus:

Press the **MF** button.



You cannot change the AF frame setting while focusing manually. Cancel the manual focus mode, then change the AF frame setting.

Using the Manual Focus in Combination with the Auto Focus (Safety MF)

First, manual focus is used to roughly focus, then from that focus position the camera automatically focuses more accurately. You can use the following two methods.

■ Setting by the Button

1 Focus the camera with the manual focus, then press the button.

- The camera beeps and focuses to a more accurate focusing point.

■ Setting the Safety MF

1 Select [Safety MF].

1. Press the **MENU** button.
2. In the  menu, use the **↑** or **↓** button to select [Safety MF].



2 Make settings.

1. Use the ◀ or ▶ button to select [On].
2. Press the **MENU** button.



3 Focus the camera with the manual focus, then press the shutter button halfway.

- The camera focuses to a more accurate focusing point.

4 To shoot, press the shutter button all the way down (press fully).

Focus Bracketing (Focus-BKT Mode)

Available Shooting Modes >> p. 300







The camera automatically takes three shots: one at the manual focus position, and one each with focus positions preset farther and nearer. The three shots are taken at the same interval as continuous shooting (p. 111).

The farther and nearer focus positions can be set in three steps: large, medium and small.







The Focus-BKT mode is not available when shooting with the flash on. Only one image at the manual focus position will be recorded.

1 Select the Focus-BKT.

1. Press the  button.
2. Use the  or  button to select  and use the  or  button to select .
3. Press the **DISP.** button.



2 Make settings.

1. Set the amount of focus position offset with the  or  button to select.
2. Press the  button.
 - Press the  button to broaden or the  button to narrow the focusing distance from the center.



3 Shoot the image with manual focus (p. 130).

To Cancel the Focus-BKT Mode:

Select  (BKT-Off) in Step 1.

* Locking the Exposure Setting (AE Lock)

Available Shooting Modes >> p. 300

You can set the exposure and focus separately. This is effective when the contrast is too strong between the subject and background or when a subject is backlit.



Be sure to set the flash to  so that the flash does not fire. When the flash fires, the FE lock will be used (p. 136).

- 1 Turn on the LCD monitor.**
- 2 Aim the camera at the subject on which you wish to lock the exposure.**
- 3 Press the shutter button halfway and press the * button.**
 - The exposure setting will lock and  will display.
- 4 Re-aim the camera to compose the shot as desired and shoot.**

To Release the AE Lock:

Operate a button other than the * button or the control dial.



- In movie mode, AE lock can also be set/canceled (p. 106).
- After locking the AE, you can change the ISO speed with exposure fixed.

Changing the Shutter Speed and Aperture Value Combination

The automatically selected combinations of shutter speeds and aperture values can be freely changed without altering the exposure to shoot images (Program Shift).

1 Aim the camera at the subject on which you wish to lock the exposure.

2 Press the shutter button halfway and press the *** button.**

- The exposure setting will lock, and ***** will appear on the LCD monitor.



TV bar AV bar

3 Use the control dial to change shutter speed and aperture value combinations.

4 Recompose the image and shoot.



- The setting will cancel after the shot is taken.

* Locking the Flash Exposure Setting (FE Lock)



Available Shooting Modes >> p. 300

You can lock the flash exposure so that the exposure settings are correctly set regardless of the composition of your subject.

- 1 Turn on the LCD monitor.**
- 2 Press the  button and select  (flash on).**
 - If you are using an externally mounted flash, please refer to its manual for setting instructions.
- 3 Aim the camera at the subject on which you wish to lock the exposure.**
- 4 Press and hold the shutter button halfway and press the * button.**
 - The flash will pre-fire and the exposure setting will be locked.
 -  will display in the LCD monitor.
- 5 Re-aim the camera to compose the shot as desired and shoot.**

To Release the FE Lock:

Operate a button other than the * button or the control dial.



The FE lock cannot be used when [Flash Mode] in the [Flash Control] menu is set to [Manual].

Adjusting the Exposure Compensation

Available Shooting Modes >> p. 300

Adjust the exposure compensation to a positive value to avoid making the subject too dark when it is backlit or shot against a bright background. Adjust the exposure compensation to a negative value to avoid making the subject too bright in night shots or when shot against a dark background.

1 Adjust the exposure compensation.

1. Use the exposure compensation dial to adjust the exposure compensation.

- If exposure compensation is available in a shooting mode, the exposure compensation lamp will light orange.
- The exposure compensation bar and the compensation results will display in the LCD monitor.
- When shooting in AEB mode (p. 139), the compensation range for AEB shooting is displayed.

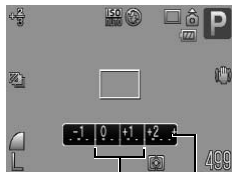

Compensation range during AEB mode
Exposure compensation bar

To Cancel the Exposure Compensation:

Follow Step 1 to restore the compensation value to [0].



In movie mode, the exposure shift can be set/canceled (p. 106).

Shooting while Brightening Dark Areas (i-Contrast)

Available Shooting Modes >> p. 300

When shooting scenes in which faces or subjects appear darkened, you can set the camera to automatically detect faces and dark areas and compensate brightness levels while shooting.

1 Select [i-Contrast].

1. Press the **MENU** button.
2. In the  menu, use the **↑** or **↓** button to select [i-Contrast].



2 Make settings.

1. Use the **←** or **→** button to select [Auto].
2. Press the **MENU** button.



When **RAW** is selected, [i-Contrast] cannot be set.









- Depending on the scene being shot, the compensation results may not be as expected.
- You can use the [i-Contrast] setting in the Play menu to apply brightness compensation to images already captured (p. 187).

Auto Exposure Bracketing (AEB Mode)

Available Shooting Modes >> p. 300

In this mode, the camera automatically changes the exposure within a set range to take three shots at the same interval as continuous shooting (p. 111). The images are shot in the following order: Standard exposure, underexposure and overexposure.

1 Select AEB.

1. Press the  button.
2. Use the  or  button to select  and use the  or  button to select .
3. Press the **DISP.** button.



2 Adjust the compensation range.

1. Adjust the compensation range with the  or  button.
2. Press the .

- The compensation range can be set as wide as 2 levels lower and 2 levels higher, in 1/3 increments, than the standard exposure value (the compensated exposure value if exposure adjustment was performed) at the center point. If exposure adjustment (p. 137) is already done, setting can be done with the adjusted value as the center point.



To Cancel the AEB Mode:

Select  in Step 1.



The AEB mode is not available when shooting with the flash on. Only one standard exposure image will be recorded.

Using the ND Filter











Available Shooting Modes >> p. 300

The ND filter reduces light intensity to 1/8 (3 stops) of the actual level, allowing for slower shutter speeds and smaller aperture values.



Always use a tripod to prevent camera shake in this mode.

1 Select ND.

1. Press the  button.
2. Use the  or  button to select  and use the  or  button to select .
3. Press the  button.







To Cancel the ND Filter:

Select .

Switching between Metering Modes

Available Shooting Modes >> p. 300

	Evaluative	Appropriate for standard shooting conditions, including backlit scenes. The camera divides images into several zones for metering. It evaluates complex lighting conditions, such as the position of the subject, the brightness, the direct light, and the backlighting, and adjusts the settings to the correct exposure for the main subject.
	Center Weighted Avg.	Averages the light metered from the entire frame, but gives greater weight to the subject matter at the center.
	Spot AE Point	Meters the area within the spot AE point frame. Use this mode when there is a large divergence in brightness between the subject and surroundings.
	Center	Locks the spot metering frame to the center of the LCD monitor.
	AF Point	Move the spot AE point to the same position as the selected AF frame. Can be set only in [FlexiZone] (p. 121).

1 Change the metering mode.

1. Press the  button.
2. Turn the control dial to select the metering mode.



- With each press of the  button, the settings that can be configured with the control dial in each shooting mode will change as follows.

Tv	Shutter speed/Metering mode
Av	Aperture value/Metering mode
M	Shutter speed/Aperture value/Metering mode

Moving the Spot AE Point to the AF Frame/ Centering the Spot AE Point

1 Select [FlexiZone].

1. Press the **MENU** button.
2. In the  menu, use the \uparrow or \downarrow button to select [AF Frame].
3. Use the \leftarrow or \rightarrow button to select [FlexiZone].



2 Select [Spot AE Point].

1. Use the \uparrow or \downarrow button to select [Spot AE Point].



3 Make settings.

1. Use the \leftarrow or \rightarrow button to select [Center] or [AF Point].
2. Press the **MENU** button.
 - When [Spot AE Point] is set to [Center], the spot AE point frame appears at the center of the LCD monitor.
 - When [AF Point] is set, it appears inside the selected AF frame.



Adjusting the Tone (White Balance)



Available Shooting Modes >> p. 300

Normally, the **AWB** (Auto) white balance setting selects an optimal white balance. When the **AWB** setting cannot produce natural looking colors, change the white balance using a setting appropriate for the light source.



	Auto	Settings are automatically set by the camera.
	Day Light	For recording outdoors on a bright day.
	Cloudy	For recording under overcast, shady or twilight skies.
	Tungsten	For recording under tungsten and bulb-type 3-wavelength fluorescent lighting.
	Fluorescent	For recording under warm-white, cool-white or warmwhite (3-wavelength) fluorescent lighting.
	Fluorescent H	For recording under daylight fluorescent, or daylight fluorescent-type 3-wavelength fluorescent lighting.
	Flash	When using the flash (cannot be set in P mode).
	Underwater	Appropriate for shooting images with the Waterproof Case WP-DC28 (sold separately). This mode yields image data in the optimal white balance to record images with natural hues by reducing the bluish tone.
	Custom	For recording with the optimal white balance data memorized in the camera from a white-colored object, such as white paper or cloth.

1 Select a white balance setting.



1. Press the button.
2. Use the or button to select **AWB** button to select or button to change the option.
3. Press the button.













The white balance setting cannot be adjusted when  or  is selected for My Colors.

Using the Custom White Balance

Take a custom white balance  (Custom 1) or  (Custom 2) reading for the following situations that are difficult for the  (Auto) setting to detect correctly.

- Shooting subjects of monotone color (such as sky, sea or forest)
- Shooting with a particular source of light (such as a mercury-vapor lamp)
- Shooting close-ups (Macro)

1 Select .

1. Press the  button.
2. Use the  or  button to select  and use the  or  button to select  or .





2 Aim the camera at a piece of white paper or cloth and press the **DISP.** button.

- Ensure that the LCD monitor is completely filled with the white image. Please note, however, that the center frame will not display when the digital zoom is used or when  is displayed.
- You can also use the optical viewfinder to take a custom white balance reading.



3 Press the button.















- You are recommended to set the shooting mode to **P** and the exposure compensation setting to $[\pm 0]$ before setting a custom white balance. The correct white balance may not be obtained when the exposure setting is incorrect (image appears completely black or white).
- When taking a white balance data reading at close range while using flash, you may not be able to obtain proper exposure. After obtaining the white balance data, be sure to check whether the proper color balance was obtained. If not, increase the distance between the camera and the white paper or cloth that you wish to use as the standard, and take the white balance data reading again.
- Shoot with the same settings as when reading the white balance data. If the settings differ, the optimal white balance may not be set. In particular, the following should not be changed.
 - ISO Speed
 - Flash:
Setting the flash to  or  is recommended. If the flash fires when reading the white balance data with the flash set to , make sure that you also use the flash when you shoot.
- Since the white balance data cannot be read in Stitch Assist mode, preset the white balance in another shooting mode beforehand.
- The white balance data is retained even after the camera power is turned off.

Shooting in a My Colors Mode



Available Shooting Modes >> p. 300

You can change the look of an image when it is shot.

	My Colors Off	Records normally with this setting.
	Vivid	Emphasizes the contrast and color saturation to record bold colors.
	Neutral	Tones down the contrast and color saturation to record neutral hues.
	Sepia	Records in sepia tones.
	B/W	Records in black and white.
	Positive Film	Use this option to make blue, green or red colors more intense like the Vivid Blue, Vivid Green or Vivid Red effects. It can produce intense natural-appearing colors like those obtained with positive film.
	Lighter Skin*	Use this option to make skin tones lighter.
	Darker Skin*	Use this option to make skin tones darker.
	Vivid Blue	Emphasize blue tints. Use to make blue subjects, such as the sky or ocean, more vivid.
	Vivid Green	Emphasize green tints. Use to make green subjects, such as mountains, new growth, flowers and lawns, more vivid.
	Vivid Red	Emphasize red tints. Use to make red subjects, such as flowers or cars, more vivid.
	Custom Color	Use this option to adjust the contrast, sharpness or saturation settings or the color balance between red, green, blue and skin tones*. It can be used to make subtle adjustments, such as making blue colors more vivid or face colors brighter.

* If the image contains colors that are the same as human skin, those colors will also be changed. You may not obtain the expected results depending on the skin color.



When the recording pixels is set to **RAW**, the My Colors cannot be set.

☐OFF / **Av** / **AvN** / **Se** / **BW** / **Ap** / **L** / **AD** / **AB** / **AG** / **AR**

1 Select a My Colors setting.

1. Press the **FUNC SET** button.
2. Use the **↑** or **↓** button to select **☐OFF** and the **←** or **→** button to change the option.
3. Press the **FUNC SET** button.



AC (Setting the Custom Color Mode)

1 Select **AC**.

1. Press the **FUNC SET** button.
2. Use the **↑** or **↓** button to select **☐OFF** and choose **AC** with the **←** or **→** button.



2 Adjust the setting.

1. Press the **DISP.** button.
2. Use the **↑** or **↓** button to select [Contrast], [Sharpness], [Saturation], [Red], [Green], [Blue] or [Skin Tone].
3. Use the **←** or **→** button to adjust the setting.



Select an item Adjust



- The adjustment results show in the LCD monitor.
 - If you press the **DISP.** button, you will return to the screen where you can select a My Colors mode.
4. Press the **FUNC SET** button.
 - Return to the shooting screen to shoot.

Changing the Colors and Shooting



Available Shooting Modes >> p. 300

You can easily change the colors in an image or movie, allowing you to enjoy producing various effects. Depending on the shooting conditions, however, the images may appear rough, or you may not get the expected color. Before photographing important subjects, we recommend taking trial shots and checking the results. By setting the [Save Original] function (p. 153) to [On] when shooting stills, you can also record both the altered image and the original, unaltered image.

	Color Accent	Use this option to have only the color specified in the LCD monitor remain and to transform all others to black and white.
	Color Swap	Use this option to transform a color specified in the LCD monitor into another. The specified color can only be swapped into one other color, and multiple colors cannot be chosen.



Depending on the scene being shot, the ISO speed may increase, increasing the amount of noise in the image.



Shooting with Color Accent Mode

1 Select or .

Still image:

1. Set the mode dial to **SCN**.
2. Use the control dial to select .

Movie:

1. Set the mode dial to .
2. Use the control dial to select .

Still image:



Movie:





2 Press the **DISP.** button.

- The camera will switch to color input mode, and the display will alternate between the original image and the Color Accent image (using the previously set color).



3 Aim the camera so that the color you wish to retain appears at the center of the LCD monitor and press the **←** button.

- Only one color can be specified.
- You can use the  or  button or the control dial to specify the range of the colors that are retained.
 - 5: Only takes the color that you want to retain.
 - +5: Also takes colors close to the one that you want to retain.

4 Press the **DISP.** button to complete the setting, then shoot.



-
- The default Color Accent is green.
 - You may not obtain the expected results after color input mode if you use the flash.
 - The specified Color Accent and color range retained even if the camera's power is turned off.

Shooting with Color Swap Mode

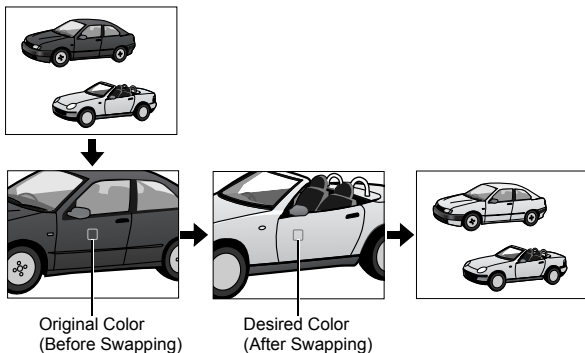



1 Select or .

Still image:

1. Set the mode dial to **SCN**.
2. Use the control dial to select .

Movie:

1. Set the mode dial to .
2. Use the control dial to select .

Still image:



Movie:



2 Press the **DISP.** button.

- The camera will switch to color input mode, and the display will alternate between the original image and the color swap image (using the previously set color).



3 Aim the camera so that the original color appears at the center of the LCD monitor and press the **←** button.

- Only one color can be specified.
- You can use the **↑** or **↓** button or the control dial to specify the range of colors that are changed.
 - 5: Only takes the color that you want to swap.
 - +5: Also takes colors close to the one that you want to swap.

4 Aim the camera so that the desired color appears at the center of the LCD monitor and press the **→** button.

- Only one color can be specified.

5 Press the **DISP.** button to complete the setting, then shoot.



- The default setting for Color Swap changes green into white.
- You may not obtain the expected results if you use the flash.
- The colors and color range specified in the Color Swap mode are retained even if the camera's power is turned off.

Saving Original Images

Not only can you save images with altered colors when shooting still images with the Color Accent or Color Swap modes, but you can also choose to save the original images (before the color change).

1 Select [Save Original].

1. Press the **MENU** button.
2. In the  menu, use the **↑** or **↓** button to select [Save Original].



2 Make settings.

1. Use the **←** or **→** button to select [On] or [Off].
2. Press the **MENU** button.



If [Save Original] is set to [On]

- The transformed image is reviewed in the LCD monitor after shooting in the Color Accent or Color Swap mode. If you erase the image at this point, the original image is erased along with the transformed image. Exercise adequate caution before deleting a file.
- Since two images are recorded with each shot, the number of shots remaining is approximately half the number displayed when this function is set to [Off].
- The images are numbered consecutively. The original images are assigned the lower number and the transformed color accent or color swap images the next number.

Categorizing Images Automatically (Auto Category)



Available Shooting Modes >> p. 300

If you set Auto Category to [On], images are automatically sorted into preset categories as they are recorded.

	People	For images shot in , or mode, or images with faces detected when in face select mode or [AF Frame] is set to [Face Detect].
	Scenery	For images shot in , , or mode.
	Events	For images shot in , , , , , or mode.

1 Select [Auto Category].

1. Press the **MENU** button.
2. In the menu, use the or button to select [Auto Category].



2 Make settings.

1. Use the or button to select [On] or [Off].
2. Press the **MENU** button.











Movies are not automatically categorized, but they can be categorized using the My Category function (p. 165).



Registering Functions to the Button

Available Shooting Modes >> p. 300

You can register a function that you often use when shooting with the  button.

Menu Item	Page	Menu Item	Page
 Not Assigned	–	 Red-Eye Corr.	p. 113
 ND Filter	p. 140	 Digital Tele-converter	p. 72
 White Balance	p. 143	 i-Contrast	p. 138
 Custom WB1, 2 (White Balance)	p. 144	 AF Lock	p. 128
		 Display Off	p. 156

1 Select [Set Shortcut button].



1. Press the **MENU** button.
2. In the  menu, use the  or  button to select [Set Shortcut button].
3. Press the  button.

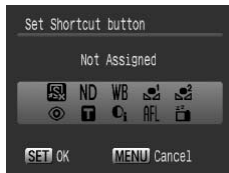

2 Make settings.

1. Use the  ,  ,  or  button to select the function you wish to register.
2. Press the  button.
3. Press the **MENU** button.



















- If  displays to the icon's lower right, you can register the function, but you cannot use it with some shooting modes or settings even if you press the  button.

To Cancel the Shortcut Button:

Select  in Step 2.

Using the Button

1 Press the button.

- , , : Each time that the  button is pressed, the settings of the registered functions are switched.
- , : The corresponding setup screen is displayed.
- , : Each press of the  button records the white balance data. Ensure that the white paper or cloth is positioned so it appears at the center of the LCD monitor and then press the  button. After using this function once, the white balance setting changes to  or .
- : Each press of the  button sets AF lock.
- : Pressing the  button turns off the LCD monitor. The display turns on again by pressing any button other than the power button or changing the camera orientation.

Setting My Menu



Available Shooting Modes >> p. 300

You can quickly access commonly used menu items from a single screen by registering them in My Menu. You can also configure My Menu to appear immediately after pressing the **MENU** button in shooting mode.

1 Select [My Menu settings].

1. Press the **MENU** button.
2. Use the **←** or **→** button to select the menu.
3. Use the **↑** or **↓** button to select [My Menu settings].
4. Press the button.



2 Select the menu items to register.

1. Use the **↑** or **↓** button to select [Select items].
2. Press the button.
3. Use the **↑** or **↓** button to select the menu item you wish to register.
4. Press the button.
 - Up to five menu items can be registered.
 - To cancel registration, press **FUNC./SET** again to remove the ✓ mark.
 - You can register a menu item even if it appears gray. However, you may not be able to use the item depending on the shooting mode.
5. Press the **MENU** button.



3 Change the order in which menu items are displayed.

1. Use the **↑** or **↓** button to select [Sort].
2. Press the **FUNC./SET** button.
3. Use the **↑** or **↓** button to select a menu item to move.
4. Press the **FUNC./SET** button.
5. Use the **↑** or **↓** button to move the menu item.
6. Press the **FUNC./SET** button.
7. Press the **MENU** button.

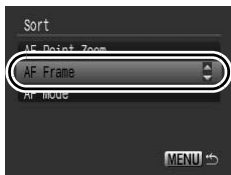
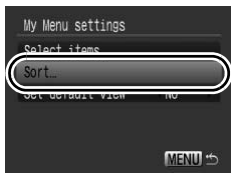

4 Set a default view.

1. Use the **↑** or **↓** button to select [Set default view].
2. Use the **←** or **→** button to select [Yes].
 - [Yes]: When pressing the **MENU** button, [My Menu] will be displayed.
 - [No]: When pressing the **MENU** button, [Rec. Menu] will be displayed.



Playback/Erasing

In playback mode, you can select images with the control dial. Turning it counterclockwise selects the previous image while turning it clockwise selects the next image. Please also see *Viewing Still Images* (p. 19).

🔍 Viewing Magnified Images



1 Press the zoom lever toward 🔍.

- A magnified portion of the image will display.
- Images can be magnified up to a factor of approximately 10x.



Approximate location of the displayed area

2 Use the ↑, ↓, ← or → button to move around the image.

- If you use the control dial while in the magnified display mode, the camera will switch to the previous or next image at the same level of magnification.
- You can change the magnification level with the zoom lever.

To Cancel the Magnified Display:

Press the zoom lever toward 📐. (You can also cancel it immediately by pressing the **MENU** button.)







📐 and index playback images cannot be magnified.

Viewing Images in Sets of Nine (Index Playback)



1 Press the zoom lever toward .

- Up to nine images can be viewed at once in index playback.
- Use the , ,  or  button or control dial to change the image selection.

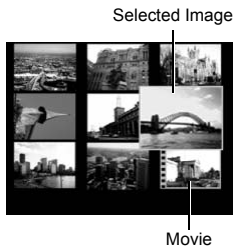





To Return to Single Image Playback:

Press the zoom lever toward .

Switching between Sets of Nine Images

The jump bar will display if you press the  button while in index playback and you can switch the display between sets of nine images.

- Pressing the zoom lever toward  also switches the display.
- Use the  or  button or control dial to move to the previous or next set of 9 images.
- Hold the **FUNC./SET** button down and press the  or  button to jump to the first or last set.

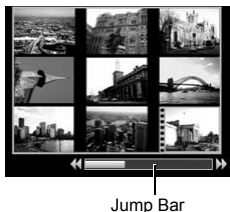

To Return to Single Image Playback:

Press the  button.

Checking the Focus and People's Expressions (Focus Check Display)

Focus Check display allows you to check the focus of images taken. Moreover, as you can change the display size and switch images, you can easily check facial expressions and whether a subject's eyes are closed.

Displaying the Focus Check

- 1 **Press the DISP. button several times until the Focus Check displays.**



- Frames are displayed on the image as follows.

Frame color	Description
Orange	Displays an area of the image at bottom right of the LCD monitor.
White	Displays on detected faces or locations the camera focuses on.
Gray	Displays frames in positions where faces were detected during playback.

- The orange frames allow you to change the display magnification, move the display position, and switch between display frames (p. 162).





Changing the Display Magnification and Display Position

2 Press the zoom lever toward .

- Bottom right of the screen will be displayed prominently and the display size and display position can be changed.



3 Change the setting.

- You can change the display size by pressing the zoom lever.
- You can change the display position by using the , ,  or  button.
- If the number of focused AF frames or detected faces is 1 or 0, the orange frame returns to its original position when you press the **FUNC./SET** button. (If you zoomed in or out on a detected face, the size of the frame will revert to the original face size.)



To Cancel Changing the Display Size and Display Position:

Press the **MENU** button.

Switching Frames







2 Press the button.

- If there are multiple focused AF frames or detected faces, the orange frame changes its position when you press the **FUNC./SET** button. (If you zoomed in or out on a detected face, the size of the frame will revert to the original face size.)



Jumping to Images

When you have many images recorded onto a memory card, it is handy to use the search keys below to jump over images to find the object of your search.

	Jump Shot Date	Jumps to the first image of each shooting date.
	Jump to My Category	Jumps to the first image of each folder sorted by the Auto Category (p. 154) or My Category (p. 165) functions.
	Jump to Folder	Displays the first image in each folder.
	Jump to Movie	Jumps to a movie.
	Jump 10 images	Jumps over 10 images at a time.
	Jump 100 images	Jumps over 100 images at a time.

1 In single image playback mode, press the button.

- The camera will switch to jump search mode.



2 Use the or button to select a search key.



- The screen sample will vary slightly according to the search key.
- You can show/hide image information using the **DISP.** button.



3 Display the Images.

   Selected

1. Use the  or  button to select date, category or folder for playback.

- You can check the target image by using the control dial.
- If you select  when an image has not been assigned to any category, you will only be able to select  (none) as a search key.

2. Press the  button.

- The camera will switch to defined playback mode and display a blue frame. You can limit playback to the images corresponding to the search key.
- Press the  button to cancel defined playback mode.

   Selected

1. Press the  or  button.

- Pressing the **MENU** button cancels the setting.
- Press the **FUNC./SET** button to switch the camera to defined playback mode when  is selected.

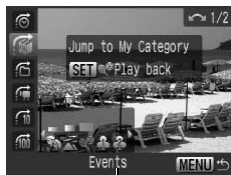

Select the search key



The defined playback mode will be canceled under the following circumstances.

- Changing categories (while using My Category to define images)
- When you press the **FUNC./SET** button while specifying a range of images, and the first or last image is displayed
- When displaying images not supported in defined playback (except when selecting images in a range)
- When newly saving images that have effects added or edited
- When images are deleted using [Erase] from the  menu

Organizing Images by Category (My Category)



You can organize images into prepared categories. Category information recorded with the [Auto Category] function (p. 154) can be edited. You can also organize one image into multiple categories. The following operations can be performed if the images are sorted into categories.

- Image searches (p. 163) • Slide Show (p. 177) • Protect (p. 197)
- Erase (p. 202) • Configure print settings (p. 207)

	People
	Scenery
	Events

	My Category 1 – 3
	To Do

Category Selection Methods

Select	For viewing and selecting images singly.
Select Range	For picking a first and last image and selecting all the images in the range.

1 Select [My Category].

1. Press the **MENU** button.
2. In the menu, use the or button to select .
3. Press the button.



2 Choose a selection method.

1. Use the or button to choose a selection method.
2. Press the button.



[Select]

3 Categorize the images.

1. Use the ◀ or ▶ button to select images to categorize.
2. Use the ▲ or ▼ button to select a category.
3. Press the  button.





- Pressing the **FUNC./SET** button again cancels the setting.
- This also can be set in the index playback mode.
- Press the **MENU** button to complete the setting.

[Select Range]



3 Select the first image.

- You can use the control dial to select the first or last image.

1. Press the  button.
2. Use the ◀ or ▶ button to select the first image in the range to categorize.
3. Press the  button.



4 Select the last image.

1. Use the **▶** button to select [Last image].
2. Press the  button.
3. Use the **◀** or **▶** button to select the last image in the range to categorize.
4. Press the  button.
 - An image with a lower number than the first image cannot be selected as the last image.
 - Up to 500 images can be selected.



5 Select a category.

1. Press the **▼** button.
2. Use the **◀** or **▶** button to select a category.



6 Make settings.

1. Press the **▼** button to select [Select].
2. Press the  button.
 - The screen will return to the selection method screen.
 - Selecting [Deselect] cancels categorization of the selected range.



Trimming a Portion of an Image





You can trim a required portion of a recorded image and save it as a new image file.

1 Select [Trimming].

1. Press the **MENU** button.
2. In the  menu, use the  or  button to select .
3. Press the  button.



2 Select an image.

1. Use the  or  button to select an image for trimming.
2. Press the  button.

- The trimming frame (the area of the image which can be trimmed) is displayed in green.

Trimming Frame



Image After Trimming

3 Adjust the trimming frame.

- You can change the size of the trimming frame using the zoom lever. However, the resolution of the saved image will differ according to the size of the trimmed image.
- You can change the position of the trimming frame using the \uparrow , \downarrow , \leftarrow or \rightarrow button.
- Press the **DISP.** button to change the vertical/horizontal orientation of the trimming frame.
- If a face is detected, a gray frame appears around the face displayed in the top left screen. Trimming can be performed around this gray frame. If multiple frames are displayed, you can switch between frames by turning the control dial.

Resolution After Trimming



4 Save the image.

- Press the **FUNC. SET** button.
 - Use the \leftarrow or \rightarrow button to select [OK].
 - Press the **FUNC. SET** button.
- The trimmed image will be saved in a new file.
 - If you wish to continue trimming of another image, repeat operations from Step 2.



5 Display the saved image.

- Press the **MENU** button.
 - Use the \leftarrow or \rightarrow button to select [Yes].
 - Press the **FUNC. SET** button.
- Selecting [No] returns to the Play menu.





- **S**, **XS**, **W** or **RAW** images, and images recorded in  cannot be trimmed.
- Some images shot with another camera cannot be trimmed.
- The aspect ratio for images which can be trimmed will be fixed to 4:3 (or 3:4 if the image is vertically oriented).
- The resolution of a trimmed image will be less than before trimming.

Viewing Movies



1 Display a movie.

1. Use the **←** or **→** button to select a movie.
2. Press the **FUNC./SET** button.

- Images with a **SET**  icon are movies.



2 Play the movie.











1. Use the **←** or **→** button to select .
2. Press the **FUNC./SET** button.

- The movie will pause if you press the **FUNC./SET** button during playback. It will resume when you press the button again.
- When playback ends, the movie stops at the last frame displayed. Press the **FUNC./SET** button to display the movie control panel.
- You can switch between showing/hiding the playback progress bar by pressing the **DISP.** button while playing a movie.
- If playback was halted partway through in the prior viewing session, playback will resume from the last frame displayed.

Movie Control Panel



Operating the Movie Control Panel

	Exit	Ends playback and returns to single image playback.
	Print	An icon will display when a printer is connected*. See the <i>Direct Print User Guide</i> for details.
	Play	Starts playback.
	Slow Motion	You can use the  button to slow down or the  button to speed up playback.
	First Frame	Displays the first frame.
	Previous Frame	Rewinds if the FUNC./SET button is held down.
	Next Frame	Fast Forwards if the FUNC./SET button is held down.
	Last Frame	Displays the last frame.
	Edit	Switches to the movie editing mode (p. 173).

* Printing is possible only from printers that support  (PictBridge) connections. For details, refer to the operating instructions for your printer.



- Movies cannot be played in the index playback mode.
- You may experience frame dropping and audio breakup when playing back a movie on a computer with insufficient system resources.



- Use the television's controls to adjust the volume when playing a movie on a TV set (p. 228).
- The sound cannot be played in slow motion playback.

Editing Movies



You can delete portions of recorded movies.



Movies 1 second or longer before editing can be edited in 1-second increments, but those that are protected or less than 1 second long cannot be edited.

1 Select [Edit].

1. In the movie control panel, use the ◀ or ▶ button to select .
2. Press the button.
 - The movie editing panel and the movie editing bar will display.



2 Edit the movie.

1. Use the ▲ or ▼ button to select (Cut Beginning) or (Cut End).
2. Use the ◀ or ▶ button to specify the cut point (↓).
 - While moving the cut point using the ◀ or ▶ button, is displayed at each 1 second interval, allowing you to cut the movie at the indicated point.
 - Even if you specify the cut point at a position other than , selecting will delete the beginning portion of the movie up to the point just before your specified cut point, and selecting will delete the latter portion of the movie from the point just after your specified cut point. The edited movie will be saved.
 - To check a temporarily edited movie, select (Play) and press the **FUNC./SET** button.
 - To continue editing, repeat Step 2.
 - Selecting (Exit) cancels the edit and restores the movie control panel.

Movie Editing Panel







Movie Editing Bar

3 Select [Save].

1. Use the  or  button to select .
2. Press the  button.

4 Save the file.

1. Use the , ,  or  button to select [New File] or [Overwrite].
2. Press the  button.



- [New File] saves the edited movie under a new file name. The pre-edit data is left unchanged. Note, if you press the **FUNC./SET** button while saving the movie, saving is canceled.
- [Overwrite] saves the edited movie with its original name. The pre-edit data is lost.
- When there is not enough space left on the memory card, only [Overwrite] can be selected.



Depending on the movie's file size, it may take some time to save an edited movie. If the battery runs out of charge partway through, edited movie clips cannot be saved. When editing movies, it is recommended to use a fully charged battery or the separately sold AC Adapter Kit ACK-DC50 (p. 258).

Rotating Images in the Display



Images can be rotated clockwise 90° or 270° in the display.



Original

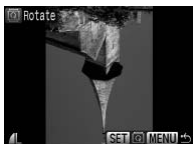

90°



270°

1 Select [Rotate].

1. Press the **MENU** button.
2. In the menu, use the or button to select .
3. Press the button.

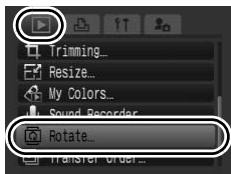

2 Rotate the image.

1. Use the or button to select an image to rotate.
2. Press the button.
 - Cycle through the 90°/270°/original orientations with each press of the **FUNC./SET** button.
 - This also can be set in the index playback mode.





When images are downloaded to a computer, the orientation of images rotated by the camera will depend upon the software used to download the images.





The orientation is recorded in the image.

Playback with Transition Effects

You can select the transition effect displayed when switching between images.

	No transition effect.
	The displayed image darkens and the next image gradually brightens until it is displayed.
	Press the ← button to have the previous image display from the left and the → button to have the next image display from the right.

1 Select [Transition].

1. Press the **MENU** button.
2. In the  menu, use the **↑** or **↓** button to select .



2 Make settings.







1. Use the **←** or **→** button to select a transition effect.
2. Press the **MENU** button.



Automated Playback (Slide Shows)

Automated playback of memory card images.

Image settings for slide shows are based on the Digital Print Order Format (DPOF) standard (p. 207).



	All Images	Plays all images on a memory card in order.
	Date	Plays images bearing a specified date in order.
	My Category	Plays the images in the selected category in order.
	Folder	Plays images in a specified folder in order.
	Movies	Plays movie files only, in order.
	Stills	Plays still images only, in order.
	Custom 1 – 3	Plays the images selected for each slide show, Custom 1, Custom 2 or Custom 3, in order (p. 180).









1 Select [Slide Show].

1. Press the **MENU** button.
2. In the  menu, use the  or  button to select .
3. Press the  button.



2 Select a playback method.

1. Press the  button.
2. Use the  or  button to select the slide show type.

- , , : Press the **FUNC./SET** button to select a date, category or folder to be played back (p. 179).
-  – : Press the **FUNC./SET** button to select the images to be played back (p. 180).
- If you want to add a transition effect to play back images, use the  button to select [Effect] and choose the type of effect with the  or  button (p. 178).



3 Start the slide show.

1. Press the **↓** button.
2. Use the **←** or **→** button to select [Start].
3. Press the  button.







- The following functions are available during slide shows.
 - Pausing/resuming: Press the **FUNC./SET** button.
 - Fast forwarding/rewinding: Press the **←** or **→** button (continue to hold the button to switch between images more rapidly).

To Stop the Slide Show:

Press the **MENU** button.

Transition Effects

You can select the transition effect used when one image is replaced by another.

	No transition effect.
	The new image gradually brightens as it moves upward from the bottom.
	The new image first appears in a cross shape and gradually expands to display the full image.
	Portions of the new image move horizontally, then the image expands to display the full image.



In single image playback mode, you can start a slide show from the current image displayed by holding the **FUNC./SET** button while you press the  button.

Select a date/category/folder to play back (, ,)

1



Select a playback method.

1. Use the  or  button to select ,  or .
2. Press the  button.





2

Select images to play back.

1. Use the  or  button to select a date/category/folder to playback.
2. Press the  button.



- A ✓ will appear on selected images.
- To cancel the selection: Press the **FUNC./SET** button again.
- Multiple selections can be made for the date/category/folder.
- The images will play back in the order of selection (except when selecting category).
- You can check the images for each date/category/folder by using the  or  button.
- Pressing the **MENU** button completes the setting.

Selecting Images for Playback (#1 – #3)

Select only the images that you wish to play back and save them as a slide show (Custom 1, 2 or 3). Up to 998 images can be selected. They will be played back in their order of selection.

1

Select a playback method.

- Use the ◀ or ▶ button to select #1, #2 or #3.

- Only the #1 icon will display at first.

- Press the  button.

- When you set #1, the icon will change to #1✓ and #2 will display. #2 and #3 will change in the same way when they are set.



2

Select images to play back.

- Use the ◀ or ▶ button to select images to play back.

- Press the  button.

- A ✓ will appear on selected images.
- To cancel the selection: Press the **FUNC./SET** button again.
- You can also select images in the index playback mode.
- Pressing the **MENU** button completes the setting.

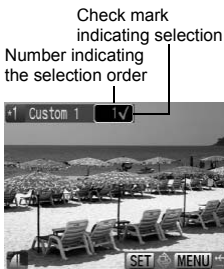



Selecting All Images

1. After selecting ***1** – ***3** in Step 1, use the **▲** button to select [Mark all] and press the **FUNC./SET** button.
2. Use the **▲** button to select [Mark all], press the **FUNC./SET** button.
3. Use the **▶** button to select [OK] and press the **FUNC./SET** button.

To deselect all images, select [Reset].

Adjusting the Play Time and Repeat Settings

• Play Time

Sets the duration that each image displays. Choose between 3 – 10 seconds, 15 seconds and 30 seconds. Displaying time can vary slightly depending on the image.

• Repeat

Sets whether the slide show stops when all the slides have been displayed or continues until stopped.

1 Select [Set up].

1. Use the **◀** or **▶** button to select [Set up].
2. Press the  button.

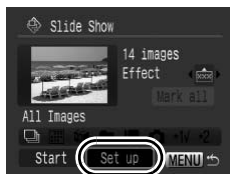

2 Configure the setting.

1. Use the **▲** or **▼** button to select [Play Time] or [Repeat].
2. Use the **◀** or **▶** button to select a setting.
3. Press the **MENU** button.



Red-Eye Correction Function



You can correct red eyes in recorded images.



Red eyes may not be automatically detected in some images or the results may not turn out as you intended. We recommend that you use [New File] to save corrected images.

Examples:

- Faces near the screen edges or faces that appear extremely small, large, dark or bright in relation to the overall image.
- Faces turned to the side or at a diagonal, or faces with a portion hidden.

1 Select [Red-Eye Correction].

1. Press the **MENU** button.
2. In the  menu, use the **↑** or **↓** button to select .
3. Press the  button.



2 Select an image.

1. Use the **←** or **→** button to select the image you wish to correct red eyes.
2. Press the  button.

- A frame will automatically display where red-eye is detected.
- If red-eye is not automatically detected, select [Add Frame] with the **↑**, **↓**, **←** or **→** button and press **FUNC./SET** button (p. 185).
- To cancel the correction frame, select [Remove Frame] and press the **FUNC./SET** button (p. 186).



3 Correct the image.

1. Use the **↑**, **↓**, **←** or **→** button to select [Start].
2. Press the  button.



4 Save the image.

1. Use the **↑**, **↓**, **←** or **→** button to select [New File] or [Overwrite].
2. Press the  button.

- [New File]: Saved as new file with a new name. The uncorrected image is stored. The new image is stored as the last file.
- [Overwrite]: Saved with the same file name as the uncorrected image. The uncorrected image is erased.
- When [New File] is selected, proceed to Step 5.
- If you wish to continue correcting another image, repeat operations from Step 2.





5 Display the saved image.

1. Press the **MENU** button.
2. Use the **←** or **→** button to select [Yes].
3. Press the  button.

- Selecting [No] returns to the Play menu.





- Red-eye correction cannot be performed on  and RAW images. When shooting in [Record  + ], red-eye correction can be performed on the JPEG image, but the original image cannot be overwritten.
- Overwriting cannot be performed on protected images.
- When there is not enough space left on the memory card, red-eye correction cannot be performed.



- Although you can apply red-eye correction any number of times to an image, the image quality will gradually deteriorate with each application.
- Since the correction frame will not appear automatically on images that have already been corrected once with the Red-Eye Correction function, use the [Add Frame] option to correct them.

Add Correction Frame

1 Select [Add Frame].

1. Use the \uparrow , \downarrow , \leftarrow or \rightarrow button to select [Add Frame].
2. Press the  button.

- A green frame will display.



2 Adjust the position of the correction frame.

1. Use the \uparrow , \downarrow , \leftarrow or \rightarrow button to move the frame.
- Size of the frame can be changed with the zoom lever.



3 Add additional correction frames.

1. Press the  button.

- A correction frame is added and the frame color changes to white.
- If you wish to add additional frames, adjust the position and press the **FUNC./SET** button.
- Up to 35 frames can be added.
- To end the adding of correction frames, press the **MENU** button.



To correctly perform red-eye correction, take note of the following (refer to the image in Step 2):

- Adjust the correction frame size so that it only surrounds the red-eye portion to be corrected.
- When there are several subjects with red-eye, be sure to add one correction frame per subject.

Removing Correction Frames

1 Select [Remove Frame].

1. Use the **↑**, **↓**, **←** or **→** button to select [Remove Frame].
2. Press the  button.



2 Select a frame you wish to remove.

1. Use the **←** or **→** button to select a frame to remove.
- The selected frame will appear in green.



3 Delete the frame.

1. Press the  button.
- The selected frame will disappear.
 - To continue deleting frames, repeat operations from Step 2.
 - When you finish deleting frames, press the **MENU** button.

Brightening Dark Areas (i-Contrast)

You can automatically detect and brighten dark areas in an image, and then save it as a new image.

1 Select [i-Contrast].

1. Press the **MENU** button.
2. In the  menu, use the  or  button to select .
3. Press the  button.



2 Select the image to brighten.

1. Use the  or  button to select an image.
2. Press the  button.



3 Select the brightness compensation level.

1. Use the  or  button to select the option.
2. Press the  button.



- If you are not satisfied with the results of [Auto], select [Low], [Medium], or [High].

4 Save the image.

1. Use the ◀ or ▶ button to select [OK].
2. Press the  button.
 - If you wish to continue compensating of another image, repeat operations from Step 2.



5 Display the saved image.

1. Press the **MENU** button.
2. Use the ◀ or ▶ button to select [Yes].
3. Press the  button.
 - Selecting [No] returns to the Play menu.



- Depending on the image, the picture quality may drop and the compensation results may not be as expected.
- You can perform brightness compensation an unlimited number of times, but the picture quality may drop.
- You cannot perform brightness compensation on RAW images.

Adding Effects with the My Colors Function



You can add effects to recorded images (stills only) using the My Colors function. The following selection of My Colors effects is available. For details, see p. 146.

	Vivid		Lighter Skin Tone
	Neutral		Darker Skin Tone
	Sepia		Vivid Blue
	B/W		Vivid Green
	Positive Film		Vivid Red

1 Select [My Colors].

1. Press the **MENU** button.
2. In the menu, use the or button to select .
3. Press the button.



2 Select an image.

1. Use the or button to select an image.
2. Press the button.



3 Select a My Colors type.

- Use the ◀ or ▶ button to select the My Colors type.
 - The displayed image will reflect the My Colors effect.
 - You can press the zoom lever toward 🔍 to check the image at a higher magnification. While the image is zoomed, you can press the **FUNC./SET** button to switch between the image transformed with the My Colors effect and the original non-transformed image.
- Press the  button.



4 Save the image.

- Use the ◀ or ▶ button to select [OK].
- Press the  button.
 - The newly saved image transformed with the My Colors effect will be the last one in the list.
 - To continue adding effects to other images, repeat the procedures from Step 2 onward.



5 Display the saved image.

- Press the **MENU** button.
- Use the ◀ or ▶ button to select [Yes].
- Press the  button.
 - Selecting [No] returns to the Play menu.





- You cannot add effects to RAW images using the My Colors function.
- When there is not enough space left on the memory card, the My Colors effects cannot be added.



- Although My Colors effects can be added any number of times to an image, the image quality will gradually deteriorate with each application and the intended colors may not be achieved.
- Color in images taken using My Colors (p. 146) in shooting mode and images edited with the My Colors function in playback mode may differ slightly.

Resizing Images



You can resave images that were recorded at high recording pixel settings at lower settings.

M3	1600 × 1200 pixels
S	640 × 480 pixels
XS	320 × 240 pixels

1 Select [Resize].

1. Press the **MENU** button.
2. In the menu, use the or button to select .
3. Press the button.



2 Select an image.

1. Use the or button to select an image to resize.
 2. Press the button.
- You cannot select the images that cannot be resized by pressing the **FUNC./SET** button.



3 Select a resolution.

1. Use the or button to select a resolution.
 2. Press the button.
- If a resolution cannot be selected due to a lack of free space on the memory card, will display.



4 Save the image.

1. Use the ◀ or ▶ button to select [OK].
2. Press the  button.

- The resized image will be saved in a new file. The original image will remain.
- If you wish to continue resizing of another image, repeat operations from Step 2.



5 Display the saved image.

1. Press the **MENU** button.
2. Use the ◀ or ▶ button to select [Yes].
3. Press the  button.

- Selecting [No] returns to the Play menu.



 and images shot in **W** or **RAW** mode cannot be resized.



🎤 Attaching Sound Memos to Images

In playback mode, you can attach sound memos (up to 1 min.) to an image. The sound data is saved in the WAVE format.

1 Press the 🎤 button while playing back images.

- The sound memo control panel will display.

2 Record.

1. Use the ◀ or ▶ button to select .
2. Press the  button.

- The elapsed time and the remaining time display.
- Pressing the **FUNC./SET** button pauses the recording. Pressing it again resumes recording.
- Up to 1 minute of recordings can be added to any one image.
- The sound mode can be changed (p. 108).
- Press the 🎤 button to stop the recording session.







Sound Memo Panel

Elapsed Time/
Remaining Time

Volume _____
(Adjust it with the ▲ or ▼
button)

Sound Memo Panel

Use the ◀ or ▶ button to select and press the **FUNC./SET** button.

	Exit	Returns to the playback screen.
	Record	Starts recording.
	Pause	Pauses recording or playback.
	Play	Begins playback.
	Erase	Erases sound memos. (Select [Erase] and in the confirmation screen press the FUNC./SET button.)



- You cannot attach sound memos to .
- Sound memos for protected images cannot be erased.

Sound-Only Recording (Sound Recorder)

You can record sound only, without images, for up to two hours at one time.

1 Select [Sound Recorder].

1. Press the **MENU** button.
2. In the  menu, use the \uparrow or \downarrow button to select .
3. Press the  button.



2 Record a sound.

1. Use the \leftarrow or \rightarrow button to select .
2. Press the  button.

- Recording time will be displayed.
- Use the \uparrow or \downarrow button to change the sample rate. Sound quality will improve in the order of [11.025kHz], [22.050kHz], [44.100kHz], but the recorded file size will also increase respectively.
- When pressing the **FUNC./SET** button, recording will pause. Pressing the button once again will resume recording.
- Pressing the shutter button halfway will stop sound recording and switch the camera to shooting mode.
- The sound mode can be changed (p. 108).

Sampling Rate

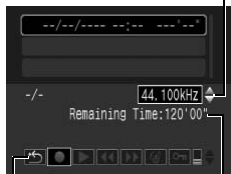









Sound Control Panel

Available Recording Time

Sound Recorder Panel

Use the **←** or **→** button to select an option and press the **FUNC./SET** button.

	Exit	Returns to the menu screen.
	Record	Starts recording.
	Pause	Stops recording, playback.
	Play	Use the ↑ or ↓ button to select a sound to play and press the FUNC./SET button.
	Rewind	Holding down the FUNC./SET button rewinds. The sound cannot be heard while rewinding.
	Fast Forward	Holding down the FUNC./SET button fast forwards. The sound cannot be heard while fast forwarding.
	Erase	Use the ↑ , ↓ , ← or → button to select [Erase] or [Erase all] in the confirmation screen and press the FUNC./SET button.
	Protect	Protects against accidental erasure. Use the ↑ or ↓ button to select a sound and the FUNC./SET button to select/deselect protection.
	Volume	You can use the ↑ or ↓ button to adjust the volume.



Make sure [Audio] settings are correct (p. 108) before recording.



- See *Sound Recorder Data Rates and Recording Durations (Estimated)* (p. 283).
- When the memory cards fills, recording will automatically stop.
- If you press and hold the  button during playback, the screen in Step 2 will display (briefly pressing the button will bring up the sound memo panel (p. 194)).

Protecting Images



You can protect important images and movies from accidental erasure.



Select	You can configure the protection settings for each image singly while viewing them.
Select Range	You can select a first and last image and protect all the images in the range.
Select by Date	You can protect the images from a specified date.
Select by Category	You can protect the images in a specified category.
Select by Folder	You can protect the images in a specified folder.
All Images	You can protect all the images on a memory card.

1 Select [Protect].

1. Press the **MENU** button.
2. In the  menu, use the  or  button to select .
3. Press the  button.



2 Choose a selection method.

1. Use the  or  button to choose a selection method.
 - Pressing the **MENU** button returns to the prior screen.
2. Press the  button.

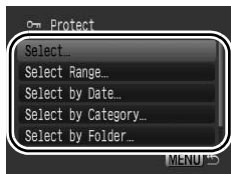

[Select]**3 Protect the image.**

1. Use the ◀ or ▶ button to select an image to protect.

2. Press the  button.

- Pressing the **FUNC./SET** button again cancels the setting.
- To continue protecting other images, repeat the procedure.
- You can also protect images in the index playback mode.
- Press the **MENU** button to complete the setting.



Protection Icon

[Select Range]**3 Select the first image.**

• You can use the control dial to select the first or last image.



1. Press the  button.

2. Use the ◀ or ▶ button to select the first image in the range to protect.

3. Press the  button.



4 Select the last image.

1. Use the **▶** button to switch to selecting the last image.
 2. Press the  button.
 3. Use the **◀** or **▶** button to select the last image in the range.
 4. Press the  button.
- An image with a lower number than the first image cannot be selected as the last image.
 - Up to 500 images can be selected.





5 Protect the images.

1. Press the **▼** button to select [Protect].
 2. Press the  button.
- The screen will return to the selection method screen.
 - Selecting [Unlock] cancels selection of the protected image.



[Select by Date]/[Select by Category]/[Select by Folder]

3 Select the images.

- Use the **↑** or **↓** button to select a date/category/folder to protect.
- Press the  button.
 - A **✓** will appear on selected images.
 - Pressing the **FUNC./SET** button again cancels the setting.
 - If a portion of the images are already protected,  appears gray.
 - You can select multiple dates, categories or folders.
 - Use the **←** or **→** button to confirm each date, category or folder image.
- Press the **MENU** button.



4 Protect the images.

- Use the **↑** or **↓** button to select [Protect].
- Press the  button.
 - Returns to the selection method screen.
 - Selecting [Unlock] removes protection for the selected images.
 - Selecting [Stop] cancels protection settings for the current selection.



[All Images]

3 Protect the images.

1. Use the **↑** or **↓** button to select [Protect].
2. Press the  button.

- Returns to the selection method screen.
- Selecting [Unlock] removes protection for all the images.
- Selecting [Stop] cancels protection settings for the current selection.



You may cancel the operation by pressing the **FUNC./SET** button during [Protect] mode.

Erasing Images



You can erase images from a memory card.



- Note that erased images cannot be recovered. Exercise adequate caution before erasing an image.
- Protected images cannot be erased with this function.

Select	Erase images after selecting them one at a time.
Select Range	For picking a first and last image and erasing all the images in the range.
Select by Date	Erases images corresponding to the selected date.
Select by Category	Erases images in the selected category.
Select by Folder	Erases images in the selected folder.
All Images	Erases all images on a memory card.

1



Select [Erase].

1. Press the **MENU** button.
2. In the  menu, use the  or  button to select .
3. Press the  button.



2

Select an erasure method.

1. Use the  or  button to select an erasure method.
 - Pressing the **MENU** button returns to the prior screen.
2. Press the  button.

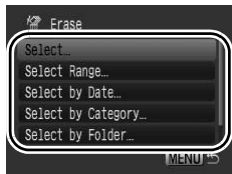

[Select]**3 Select the image.**

1. Use the **←** or **→** button to select an image to erase.
2. Press the  button.
 - Pressing the **FUNC./SET** button again deselects the setting.
 - This also can be set in the index playback mode.
3. Press the **MENU** button.

**4 Erase the image.**



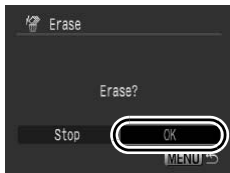

1. Use the **←** or **→** button to select [OK].
2. Press the  button.
 - Selecting [Stop] cancels selection of the image you are about to erase and returns to Step 2.



[Select Range]





3 Select the first image.

- You can use the control dial to select the first or last image.

- Press the  button.
- Use the  or  button to select the first image in the range to erase.
- Press the  button.





4 Select the last image.

- Use the  button to switch to selecting the last image.
 - Press the  button.
 - Use the  or  button to select the last image in the range.
 - Press the  button.
- An image with a lower number than the first image cannot be selected as the last image.
 - Up to 500 images can be selected.



5 Erase the images.





1. Press the  button to select [Erase].
2. Press the  button.

- Pressing the **MENU** button cancels selection of the image you are about to erase and returns to Step 2.



[Select by Date]/[Select by Category]/[Select by Folder]

3 Select the images.

1. Use the  or  button to select a date/category/folder to erase.
2. Press the  button.
 - A  will appear on selected images.
 - Pressing the **FUNC./SET** button again cancels the setting.
 - You can select multiple dates, categories or folders.
 - Use the  or  button to confirm each date, category or folder image.
3. Press the **MENU** button.



4 Erase the images.

1. Use the  or  button to select [OK].
2. Press the  button.
 - Selecting [Stop] cancels selection of the image you are about to erase and returns to Step 2.

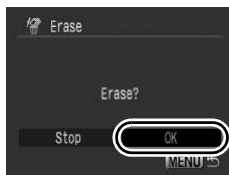

[All Images]

3 Erase the images.

1. Use the ← or → button to select [OK].

2. Press the  button.

- Selecting [Cancel] cancels selection of the image you are about to erase and returns to Step 2.



- Pressing the **FUNC./SET** button while erasing is in progress cancels the procedure.
- Please format the memory card when you want to erase not only image data but also all the data contained on the memory card (pp. 16, 220).



Print Settings/Transfer Settings

You can also use the control dial to select images and perform various operations. See p. 43.

Setting the DPOF Print Settings

You can select images on a memory card for printing and specify the number of print copies in advance using the camera. The settings used on the camera comply with the Digital Print Order Format (DPOF) standards. This is extremely convenient for printing on a direct print compatible printer, or for sending the images to a photo developing service that supports DPOF.







- The specified print settings are also applied to the Print List (p. 23).
- The output of some printers or photo developing services may not reflect the specified print settings.
- Print settings cannot be set for  and .
- The  icon may display for a memory card with print settings set by a different DPOF-compliant camera. These settings will be overwritten by those set by your camera.







Setting the Print Style

After setting the print style, select the images for printing. The following settings can be selected.

* Default setting



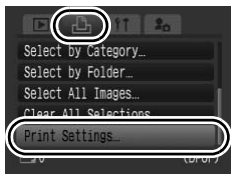

Print Type	 Standard*	Prints one image per page.
	 Index	Prints the selected images together at a reduced size in an index format.
	 Both	Prints the images in both the standard and index formats.
 Date (On/Off*)	Adds the date to the print.	
 File No. (On/Off*)	Adds the file number to the print.	
Clear DPOF data (On*/Off)		Clears all print settings after the images print.

1 Select [Print Settings].

1. Press the  button.
2. Press the **MENU** button.
3. Use the  or  button to select the  menu.
4. Use the  or  button to select [Print Settings].
5. Press the  button.



2 Make settings.

1. Use the  or  button to select an option.
2. Use the  or  button to specify the settings.
3. Press the **MENU** button.

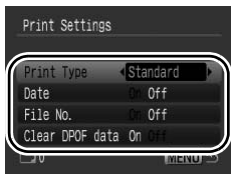

- The Date and File No. settings change according to the Print Type as follows.
 - [Index]:
[Date] and [File No.] cannot be set to [On] at the same time.
 - [Standard] or [Both]:
[Date] and [File No.] can be set to [On] at the same time, however, the printable information may vary between printers.
- Dates print in the style specified in [Date/Time] in the  menu (p. 60).







Single Images

Select Images & Qty.	Configures print settings for single images as you view them.
Select Range	For picking a first and last image and printing all the images in the range.
Select by Date	Configures print settings for images corresponding to the selected date.
Select by Category	Configures print settings for images in the selected category.
Select by Folder	Configures print settings for images in the selected folder.
Select All Images	Configures print settings for all images.
Clear All Selections	Removes all print settings from images.



Only one copy will be printed for each selected image. With the [Select Images & Qty.] option, you can only set the number of copies to print when the [Print Type] option is set to [Standard] or [Both] (p. 207).

1 Choose a selection method.

1. Press the  button.
2. Press the **MENU** button.
3. Use the  or  button to select the  menu.
4. Use the  or  button to choose a selection method.
5. Press the  button.

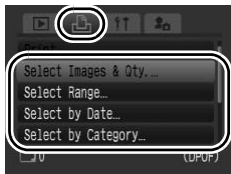

[Select Images & Qty.]

2 Select the images.

Selection methods differ depending on the Print Type settings (p. 207).

Standard (■)/Both (■) (■)

1. Use the ◀ or ▶ button to select the images.
2. Press the  button.
3. Use the ▲ or ▼ button to select the number of print copies (up to 99).
4. Press the **MENU** button.

Index (■)

1. Use the ◀ or ▶ button to select the images.
2. Select and deselect with the  button.
3. Press the **MENU** button.

- This also can be set in the index playback mode.

Number of Print Copies



Index Print Selection





[Select Range]

2 Select the first image.

- You can use the control dial to select the first or last image.

1. Press the  button.

2. Use the  or  button to select the first image in the print range.

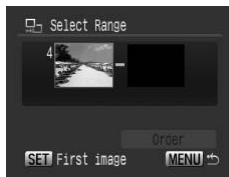

3. Press the  button.



3 Select the last image.

1. Use the  button to switch to selecting the last image.

2. Press the  button.

3. Use the  or  button to select the last image in the range.

4. Press the  button.

- An image with a lower number than the first image cannot be selected as the last image.

- Up to 500 images can be selected.



4 Configure the print settings.

1. Press the **↓** button to select [Order].
2. Press the  button.

- The screen will return to the selection method screen.
- Pressing the **MENU** button cancels the print settings for the selected range of images.



[Select by Date]/[Select by Category]/[Select by Folder]

2 Select the images.

1. Use the **↑** or **↓** button to select a date/category/folder to print.

2. Press the  button.

- A **✓** will appear on selected images.
- Pressing the **FUNC./SET** button again cancels the setting.
- You can select multiple dates, categories or folders.
- Use the **←** or **→** button to confirm each date, category or folder image.

3. Press the **MENU** button.

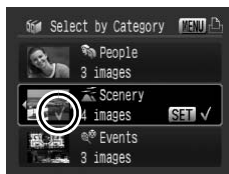

3 Configure the print settings.

1. Use the **←** or **→** button to select [OK].

2. Press the  button.

- The screen will return to the selection method screen.
- Selecting [Stop] cancels print settings of the selected image.



[Select All Images]

2 Configure the print settings.

1. Use the ← or → button to select [OK].

2. Press the  button.

- The screen will return to the selection method screen.
- Selecting [Cancel] cancels print settings of the selected image.

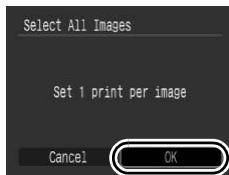

[Clear All Selections]



2 Deselect the images.

1. Use the ← or → button to select [OK].

2. Press the  button.

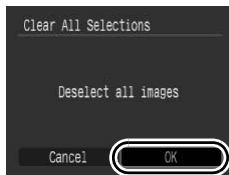
- The screen will return to the selection method screen.
- Selecting [Cancel] cancels the operation.



- Images are printed in order according to the file number.
- A maximum of 998 images can be selected.
- When the camera is connected to a printer, the  button will light blue. At this time, printing will begin after performing the following.
 1. Press the  button.
 2. Confirm that [Print] is selected, then press the **FUNC./SET** button.

Setting the DPOF Transfer Settings

You can use the camera to specify settings for images before downloading to a computer. Refer to the *Software Starter Guide* for instructions on how to transfer images to your computer. The settings used on the camera comply with the DPOF standards.





The  icon may display for a memory card with transfer settings set by a different DPOF-compliant camera. These settings will be overwritten by those set by your camera.

1 Select [Transfer Order].

1. Press the  button.
2. Press the **MENU** button.
3. In the  menu, use the  or  button to select .
4. Press the  button.



2 Select an order method.

1. Use the  or  button to select an order method.
 - Order : Select single images.
 - Mark all : Select all the images on a memory card.
2. Press the  button.



- Selecting [Reset] cancels all transfer order settings.

Single Images

3 Select an image to transfer.

1. Use the **←** or **→** button to select an image to transfer.
2. Press the **FUNC./SET** button.
 - Pressing the **FUNC./SET** button again deselects the setting.
 - This also can be set in the index playback mode.
3. Press the **MENU** button several times.

Transfer Selection



Mark all

3 Transfer images.

1. Use the **←** or **→** button to select [OK].
2. Press the **FUNC./SET** button.
3. Press the **MENU** button several times.



- Images are transferred in order according to the file number.
- A maximum of 998 images can be selected.

Configuring the Camera

Power Saving Function



This camera is equipped with a power saving function, which can automatically turn off the power or LCD monitor.

Auto Power Down	<p>When set to [On], the power will shut off in the following circumstances. Press the power button again to restore power.</p> <p>Shooting mode: Approximately 3 minutes after the last control is accessed on the camera.</p> <p>Playback mode or when connected to a printer: Approximately 5 minutes after the last control is accessed on the camera.</p>
Display Off	<p>In shooting mode, the LCD monitor automatically turns off after the selected time if no control is accessed, regardless of the [Auto Power Down] setting. Press any button other than the power button or change the camera orientation to turn the LCD monitor back on.</p>

1 Select [Power Saving].

1. Press the **MENU** button.
2. Use the **←** or **→** button to select the **⏏** menu.
3. Use the **↑** or **↓** button to select [Power Saving].
4. Press the **FUNC. SET** button.

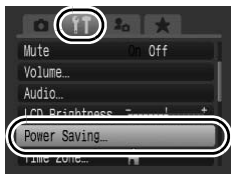

2 Make settings.

1. Use the **↑** or **↓** button to select an option.
2. Use the **←** or **→** button to make settings.
3. Press the **MENU** button.



3 Press the **MENU** button.



The power saving function will not activate during a slide show or while the camera is connected to a computer.

Setting the World Clock



When traveling abroad, you can record images with local dates and times simply by switching the time zone setting if you pre-register the destination time zones. You can enjoy the convenience of not having to switch the Date/Time settings.

Setting the Home/World Time Zones

1 Select [Time Zone].

1. Press the **MENU** button.
2. Use the **←** or **→** button to select the **⌂** menu.
3. Use the **↑** or **↓** button to select [Time Zone].
4. Press the **FUNC./SET** button.





2 Select **⌂** (Home).

1. Use the **↑** or **↓** button to select **⌂**.
 2. Press the **FUNC./SET** button.
- When using for the first time, confirm that the screen to the right appears, then press the **FUNC./SET** button.



3 Select an area as home.

1. Use the **←** or **→** button to select a home time zone.
2. Press the  button.
 - To set the daylight saving option, use the **↑** or **↓** button to display . The time will advance by 1 hour.

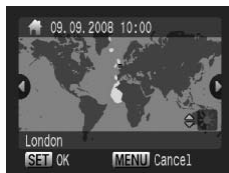

4 Select (World).

1. Use the **↓** button to select .
2. Press the  button.



5 Select a destination area.

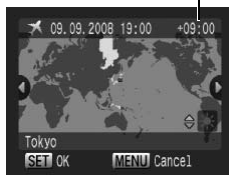

1. Use the **←** or **→** button to select a destination time zone.
2. Press the  button.
 - As in Step 3, you can set daylight saving time.

Time Difference from the Home Time Zone





Switching to the Destination Time Zone

1 Select [Time Zone].

1. Press the **MENU** button.
2. Use the **←** or **→** button to select the  menu.
3. Use the **↑** or **↓** button to select [Time Zone].
4. Press the  button.



2 Select (World).

1. Use the  or  button to select .
2. Press the **MENU** button twice.

- To change the destination time zone, use the **FUNC./SET** button.
- When you switch to the destination time zone,  will display on the LCD monitor.



If you do not select a home time zone beforehand, you cannot configure the destination time.



If you change the date and time when the World option is selected, the Home date and time will also change automatically.



Low Level Formatting Memory Cards

We recommend you select [Low Level Format] when you think that the recording/reading speed of a memory card has dropped.



Please note that formatting (initializing) a memory card erases all data (including protected images (p. 197) and sound data recorded with the sound recorder (p. 195)).

1 Select [Format].

1. Press the **MENU** button.
2. Use the **←** or **→** button to select the  menu.
3. Use the **↑** or **↓** button to select [Format].
4. Press the  button.



2 Make settings.

1. Use the **↑** button to select [Low Level Format].
2. Use the **←** or **→** button to add a check mark.
3. Use the **↑**, **↓**, **←** or **→** button to select [OK].
4. Press the  button.

Displays when sound data recorded with the sound recorder is present.

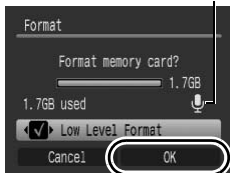

- You can stop formatting a memory card by pressing the **FUNC./SET** button. You can still use a memory card without problem when formatting is halted, but its data will be erased.
- A low level format may require 2 to 3 minutes with some memory cards.

Resetting the File Number



The images you shoot are automatically assigned file numbers. You can select how the file number is assigned.

Continuous	<p>A number one higher than the last one recorded is assigned to the next image. This is convenient for managing all your images together on a computer because you avoid file name duplication when changing folders or memory cards.*</p> <p>* When a blank memory card is used. If a memory card with recorded data is used, the 7-digit number for the last recorded folder and image is compared with the last one on the memory card, and the larger of the two is utilized as the basis for new images.</p>
Auto Reset	<p>The image and folder number are reset to the starting value (100-0001).* This is convenient for managing images on a folder-by-folder basis.</p> <p>* When a blank memory card is used. If a memory card with recorded data is used, the number following the 7-digit number for the last recorded folder and image on the memory card is utilized as the basis for new images.</p>

1 Select [File Numbering].

1. Press the **MENU** button.
2. Use the **←** or **→** button to select the **File Numbering** menu.
3. Use the **↑** or **↓** button to select [File Numbering].

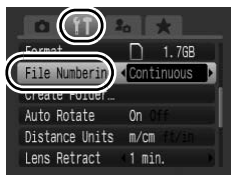

2 Make settings.

1. Use the **←** or **→** button to select a file numbering setting.
2. Press the **MENU** button.



File and Folder Numbers

Recorded images are assigned consecutive file numbers starting with 0001 and ranging up to 9999, while folders are assigned numbers starting with 100 and ranging up to 999. Up to 2000 images can be saved into a single folder.

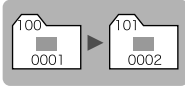
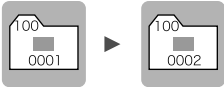
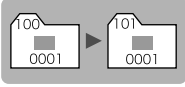
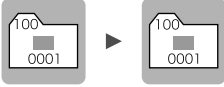
	New Folder Created	Memory Card Exchanged for Another
Continuous	<p>Memory Card 1</p> 	<p>Memory Card 1 Memory Card 2</p> 
Auto Reset	<p>Memory Card 1</p> 	<p>Memory Card 1 Memory Card 2</p> 

- Images may be saved to a new folder when there is insufficient free space even if the total number of images in a folder is less than 2000 because the following types of images are always saved together into the same folder.
 - Images from continuous shooting
 - Self-timer images (Custom and FaceSelf-Timer)
 - Movies
 - Stitch Assist mode images
 - Focus Bracketing
 - AEB shooting
 - Still images shot in Color Accent/Color Swap mode with the [Save Original] category set to [On].
- Images cannot be played back when the folder numbers are duplicated or image numbers are duplicated within folders.
- Please refer to the *Software Starter Guide* for information regarding folder structures or image types.



Creating an Image Destination (Folder)

You can create a new folder at any time and the recorded images will be automatically saved to that folder.

Create New Folder	Creates a new folder the next time you shoot images. To create an additional folder, insert the check mark again.
Auto Create	You can also specify a date and time if you wish to create a new folder using a shooting time after the specified date and time.

Creating a Folder the Next Time You Shoot

1 Select [Create Folder].

1. Press the **MENU** button.
2. Use the **←** or **→** button to select the  menu.
3. Use the **↑** or **↓** button to select [Create Folder].
4. Press the  button.

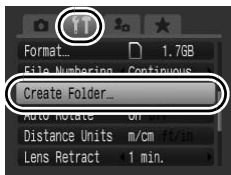

2 Make settings.

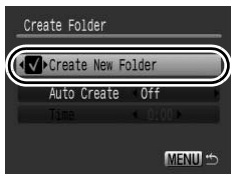

1. Use the **←** or **→** button to check mark [Create New Folder].
2. Press the **MENU** button.

-  will be displayed on the LCD monitor when shooting. The symbol will disappear from the screen when a new folder is created.



Setting the Day or Time for Automatic Folder Creation

1 Select [Create Folder].

1. Press the **MENU** button.
2. Use the **←** or **→** button to select the  menu.
3. Use the **↑** or **↓** button to select [Create Folder].
4. Press the  button.

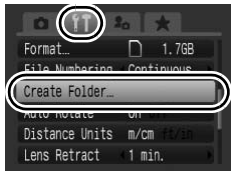

2 Make settings.

1. Use the **↑** or **↓** button to select [Auto Create] and the **←** or **→** button to select a creation date.
2. Use the **↑** or **↓** button to select [Time] and the **←** or **→** button to select a time.
3. Press the **MENU** button.

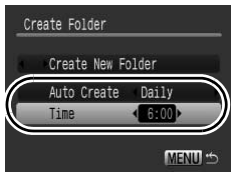

-  displays when the specified time arrives. The symbol will cease to display after the new folder is created.



Up to 2000 images can be saved into one folder. A new folder will automatically be created when you record more than that number even if you are not creating new folders.

Setting the Auto Rotate Function



Your camera is equipped with an Intelligent Orientation sensor that detects the orientation of an image shot with the camera held vertically and automatically rotates it to the correct orientation when viewing it in the LCD monitor.

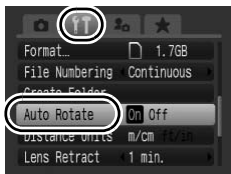

1 Select [Auto Rotate].

1. Press the **MENU** button.
2. Use the **←** or **→** button to select the  menu.
3. Use the **↑** or **↓** button to select [Auto Rotate].



2 Make settings.

1. Use the **←** or **→** button to select [On] or [Off].
2. Press the **MENU** button.

- When the Auto Rotate function is set to [On] and the LCD monitor is set to the detailed display mode in the shooting mode,  (normal),  (right end is down) or  (left end is down) will appear in the display.

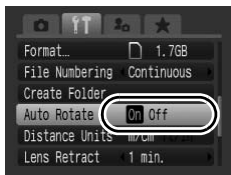

- This function may not operate correctly when the camera is pointed straight up or down. Check that the arrow  is pointing in the right direction and if it is not, then set the Auto Rotate function to [Off].
- Even if the Auto Rotate function is set to [On], the orientation of images downloaded to a computer will depend upon the software used to download the images.



When the camera is held vertically to shoot, the Intelligent Orientation sensor judges the upper end to be “up” and the lower end to be “down”. It then regulates the optimal white balance, exposure and focus for vertical photography. This function operates regardless of the on/off status of the Auto Rotate function.

Resetting Settings to Their Default Values



1 Select [Reset All].

1. Press the **MENU** button.
2. Use the **←** or **→** button to select the **ⓘ** menu.
3. Use the **↑** or **↓** button to select [Reset All].
4. Press the **FUNC/SET** button.



2 Make settings.

1. Use the **←** or **→** button to select [OK].
2. Press the **FUNC/SET** button.



- When returning the **C1/C2** registration contents to the default setting, turn the mode dial to **C1** or **C2** to operate.
- Settings cannot be reset when the camera is connected to a computer or to a printer.
- The following cannot be reset.
 - The shooting mode
 - The [Time Zone], [Date/Time], [Language] and [Video System] options in the **ⓘ** menu (p. 60)
 - ISO speed
 - Exposure compensation
 - White balance data recorded with the custom white balance function (p. 144)
 - Colors specified in the [Color Accent] (p. 149) or [Color Swap] (p. 151) mode
 - Newly added My Camera settings (p. 231)

Connecting to a TV

Shooting/Playback Using a TV



You can use the supplied AV cable to shoot or playback images using a TV.

1 Turn off the camera and the TV.

2 Connect the AV cable to the camera's A/V OUT terminal.

- Open the terminal cover, and plug the AV cable in all the way.

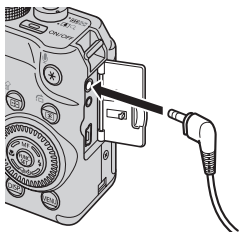

3 Plug the other ends of the AV cable to the VIDEO IN and AUDIO IN jacks on the TV.

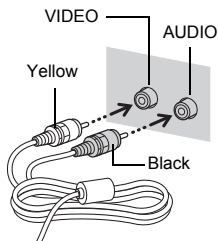

4 Turn on the TV and switch it to Video mode.

5 Turn on the camera.



- The video output signal can be switched (NTSC or PAL) to accommodate different regional standards (p. 61). The default setting varies between regions.
 - NTSC: Japan, U.S.A., Canada, Taiwan and others
 - PAL: Europe, Asia (excluding Taiwan), Oceania and others
- If the video system is set incorrectly, the camera output may not display properly.

Customizing the Camera (My Camera Settings)

You can also use the control dial to select images and perform various operations. See p. 43.

My Camera allows you to customize the start-up image and start-up, operation, self-timer and shutter sounds. You can change and register these settings, enabling you to customize the camera to suit your own tastes.

Changing My Camera Settings



1 Select a menu item.

1. Press the **MENU** button.
2. Use the **←** or **→** button to select the  menu.
3. Use the **↑** or **↓** button to select menu item.

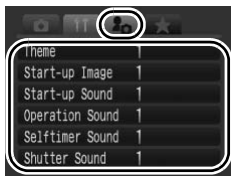

2 Make settings.

1. Use the **←** or **→** button to select contents you wish to set.
2. Press the **MENU** button.
 - Select [Theme] in sub step 3 of Step 1 to set all to the same settings.

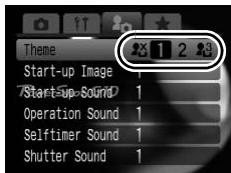

When [Shutter Sound] is set to **1** or **2**, a shutter sound matching the shutter speed will play.

Registering My Camera Settings



Images recorded onto the memory card and newly recorded sounds can be added as My Camera settings to the menu items. You can also use the supplied software to upload your computer's images and sounds to the camera.



A computer is required to restore the My Camera settings to the defaults. Use the supplied software (ZoomBrowser EX/ImageBrowser) to restore the default settings to the camera.

1 Select the menu item.

1. Press the button.
2. Press the **MENU** button.
3. Use the or button to select the menu.
4. Use the or button to select the menu item you wish to register.



2 Select .

1. Use the or button to select .
2. Press the **DISP.** button.









3 Make settings.

[Start-up Image]

1. Use the or button to select image to register.
2. Press the button.



[Start-up Sound]/[Operation Sound]/ [Self-timer Sound]/[Shutter Sound]

1. Use the ◀ or ▶ button to select  (Record).
2. Press the  button.
3. After recording, use the ◀ or ▶ button to select  (Register).
4. Press the  button.
 - Recording will automatically stop when the recording time elapses.
 - To play it, select  (Play).
 - To exit instead of registering, select  (Exit).



4 Register the setting.

1. Use the ◀ or ▶ button to select [OK].
2. Press the  button.
 - To cancel registering, select [Cancel].



- The following cannot be registered as My Camera settings.
 - Movies
 - Sounds recorded with the sound memo function (p. 194)
 - Sounds recorded with the Sound Recorder (p. 195)
- The prior setting is erased when a new My Camera setting is added.



See the supplied *Software Starter Guide* for more information on creating and adding to the My Camera data.

Troubleshooting

- Camera (p. 233)
- When the power is turned on (p. 234)
- LCD monitor (p. 234)
- Shooting (p. 236)
- Shooting movies (p. 241)
- Playback (p. 241)
- Battery/Battery Charger (p. 242)
- TV monitor output (p. 243)
- Printing with a direct print compatible printer (p. 243)

Camera

Camera will not operate.

Power is not turned on.	<ul style="list-style-type: none"> ● Press the power button (p. 42).
Memory card/battery cover is open.	<ul style="list-style-type: none"> ● Confirm that the memory card/battery cover is securely closed (p. 12).
Battery charge insufficient to operate camera ("Change the battery pack" message displays).	<ul style="list-style-type: none"> ● Insert a fully charged battery into the camera (p. 11). ● Use the AC Adapter Kit ACK-DC50 (sold separately) (pp. 37, 258).
Poor contact between camera and battery terminals.	<ul style="list-style-type: none"> ● Polish the terminals with a soft cotton swab before charging or using the battery (p. 254).

Sounds come from the camera interior.

The camera's horizontal/vertical orientation was changed.	<ul style="list-style-type: none"> ● The camera's orientation mechanism is operating. There is no malfunction.
---	---

When the power is turned on

“Card locked!” message appears.

The SD memory card's or SDHC memory card's write protect tab is set to “Write protect”.

- When recording to, erasing from or formatting the memory card, slide the write protect tab upward (p. 256).

The Date/Time menu appears.

The built-in rechargeable lithium battery charge is low.

- Recharge the built-in battery immediately (p. 10).

LCD monitor

Nothing displays.

The LCD monitor is set not to display.

- Press the **DISP.** button to turn on the LCD monitor (p. 63).

[Power Saving] is set to [Display Off].

- Press any button other than the power button or change the camera orientation to turn the LCD monitor back on (p. 216).

Camera screen is black at start-up.

Incompatible image has been selected as the startup image in the My Camera settings.

- Change the start-up image in the My Camera settings (p. 230) or use the supplied software program ZoomBrowser EX or ImageBrowser to restore the default settings. See *ZoomBrowser EX/ ImageBrowser Software User Guide (PDF)*.

The display darkens.

The image in the LCD monitor will darken in strong sunlight or bright light.

- This is a normal occurrence in devices containing CCDs and does not constitute a malfunction. This image will not be recorded when shooting still photos, but it will be recorded when shooting movies.

Display flickers.

Display flickers when shot under fluorescent lighting.

- This is not a camera malfunction (flickering recorded in movies, but not in still images).

A bar of light (purplish red) appears on the LCD monitor.

Sometimes appears when shooting a bright subject, such as the sun or other light source.

- This is a normal occurrence in devices containing CCDs and does not constitute a malfunction. This bar of light will not be recorded when shooting still photos, but it will be recorded when shooting movies.
- Setting the ND Filter on may reduce this bar of light (p. 140).

appears.

A slow shutter speed has likely been selected because of insufficient lighting.

- Set the IS Mode to any setting other than [Off] (p. 85).
- Raise the ISO speed (p. 87).
- Use the Auto ISO Shift (p. 88).
- Set the flash to any setting other than  (flash off) (p. 73).
- Set the self-timer and secure the camera to something, such as a tripod (p. 75).
- If you have an externally mounted flash, attach it (p. 265).

▲ appears.

This displays when using a memory card that has print settings or transfer settings set by other DPOF-compliant cameras.

- These settings will be overwritten by those set by your camera (pp. 177, 207, 214).

Noise displays./Subject's movements are irregular.

Camera automatically lightened the image displayed on the LCD monitor to make it easier to see when shooting in a dark area (p. 65).

- There is no effect on the recorded image.

Shooting**Camera will not record.**

Camera is in playback mode.

- Switch to the shooting mode (p. 44).

Camera is connected to a computer/printer mode.

- Switch to the shooting mode after disconnecting the interface cable in connecting to a computer/printer mode.

Flash is charging.

- When the flash is charged, the indicator will light orange. Shooting is now possible (p. 45).

Memory card is full.

- Insert a new memory card (p. 11).
- If required, download the images to a computer and erase them from the memory card to make space.

Memory card is not formatted correctly.	<ul style="list-style-type: none"> ● Format the memory card (pp. 16, 220). ● If reformatting does not work, the memory card logic circuits may be damaged. Consult the nearest Canon Customer Support Help Desk.
---	--

SD memory card or SDHC memory card is write protected.	<ul style="list-style-type: none"> ● Slide the write protect tab upward (p. 256).
--	--

Image Seen in Viewfinder vs. Recorded Image.

Usually the recorded image contains more of the scene than is seen in the viewfinder.	<ul style="list-style-type: none"> ● Confirm the actual image size with the LCD monitor. Use the LCD monitor when taking close-up shots (p. 74).
---	---

Image is blurred or out of focus.

The camera moves when the shutter button is pressed.	<ul style="list-style-type: none"> ● Confirm the procedures in “ appears” (p. 235).
--	---

AF-assist Beam is set to [Off].	<ul style="list-style-type: none"> ● In dark places where it is difficult for the camera to focus, the AF-assist Beam will emit to assist focusing. As the AF-assist Beam will not function when turned off, set it [On] to activate it (p. 56). Take care not to obstruct the AF-assist Beam with your hand when used.
---------------------------------	--

Subject is out of focal range.	<ul style="list-style-type: none"> ● Shoot with the subject at the correct focusing distance (p. 276). ● The camera may be set to an unintended function (such as macro or manual focus). Cancel the setting.
--------------------------------	---

The subject is hard to focus on.	<ul style="list-style-type: none"> ● Use the focus lock, AF lock or manual focus to shoot (p. 128).
----------------------------------	--

Subject in recorded image is too dark.

Insufficient light for shooting.	<ul style="list-style-type: none"> ● Set the built-in flash to  (Flash on) (p. 73). ● Use a high-output externally mounted flash. ● Set [ND Filter] to [Off] (p. 140).
The subject is underexposed because the surroundings are too bright.	<ul style="list-style-type: none"> ● Set the exposure compensation to a positive (+) setting (p. 137). ● Use the AE lock or spot metering functions (p. 141).
Subject is too far away for flash to reach.	<ul style="list-style-type: none"> ● Shoot within correct flash range of the subject when using the built-in flash (p. 277). ● Raise the ISO speed and then shoot (p. 87).

Subject in recorded image is too bright, or image flashes white.











Subject is too close, making the flash too strong.	<ul style="list-style-type: none"> ● Shoot within correct flash range of the subject when using the built-in flash (p. 277). ● Adjust [Flash Exp. Comp] or [Flash Output] in the [Flash Control] menu (p. 113). ● Set the safety FE to [On] (p. 114).
The subject is overexposed because the surroundings are too dark.	<ul style="list-style-type: none"> ● Set the exposure compensation to a negative (–) setting (p. 137). ● Use the AE lock or spot metering functions (p. 141). ● Set [ND Filter] to [On] (p. 140).
Too much light is shining directly into the camera, or is being reflected off the subject.	<ul style="list-style-type: none"> ● Change the shooting angle.
Flash is set to  (Flash on).	<ul style="list-style-type: none"> ● Push down the flash to  (Flash off) (p. 73).

Image contains noise.

ISO speed is too high.

- Higher ISO speeds and  (High ISO Auto) setting may increase image noise. For higher image quality, use as low an ISO speed as possible (p. 87).
- In , , , , , ,  and  modes in the **SCN** mode, or when using the Auto ISO Shift, the ISO speed increases and noise can appear.

White dots appear on the image.

Light from the flash has reflected off dust particles or insects in the air. This is particularly noticeable when shooting using the wide angle or when you increase the aperture value in the aperture priority **Av** mode.

- This is a phenomenon that occurs with digital cameras and does not constitute a malfunction.

Eyes appear red.

Light is reflected back from the eyes when the flash is used in dark areas.

- Shoot with [Red-Eye Lamp] in the [Flash Control] menu set to [On] (p. 113). For this mode to be effective, the subject must be looking right at the red-eye reduction lamp. Try asking them to look directly at the lamp. Even better results can be obtained by increasing the lighting in indoor settings or approaching closer to the subject.
- Set the [Red Eye Corr.] in the [Flash Control] menu to [On] (p. 113) and then shoot. The camera will automatically correct red eyes while shooting and record the image to the card.
- You can correct red eyes in recorded images using the [Red-Eye Correction] in the Playback menu (p. 182).

Continuous shooting slows down.

The memory card's performance has dropped.

- To enhance the continuous shooting performance, you are recommended to low level format the memory card in the camera after you save all its images to your computer (p. 220).

Recording images to memory card takes a long time.

Memory card was formatted in another device.

- Use a memory card formatted in your camera (pp. 16, 220).

Lens will not retract.

Memory card/battery cover was opened with power on.

- After closing the memory card/battery cover, turn the power on then back off.

Shooting movies

The recording time may not display properly or shooting may stop unexpectedly.

The following types of memory cards are used.

- Slow recording cards.
- Cards formatted on a different camera or a computer.
- Cards which have had images recorded and erased repeatedly.

- Although the recording time may not display properly during shooting, the movie will be recorded correctly on the memory card. Recording time will display properly if you format the memory card in this camera (excluding slow recording memory cards) (pp. 16, 220).

“!” displayed on the LCD monitor in red and shooting automatically stopped.

There is insufficient free space in the camera's built-in memory.

- Try the following procedures.
 - Format the card with a low level format before filming (p. 220).
 - Lower the recording pixels (p. 107).

Zoom does not operate.

Zoom lever was pressed while shooting in movie mode.

- Operate the zoom before shooting in movie mode (p. 69). Note the digital zoom is available while shooting (only in Standard movie mode).

Playback

Cannot play back.

You attempted to play back images shot with another camera or images edited with a computer.

- Computer images that cannot be played back may play back if they are added to the camera using the supplied software program ZoomBrowser EX or ImageBrowser. See *ZoomBrowser EX/ImageBrowser Software User Guide (PDF)*.

File name was changed with a computer or file location was changed.

- Set the file name or location on the file format/structure of the camera (refer to the *Software Starter Guide* for details).

Images cannot be edited.

Some images shot with another camera cannot be edited.

Movies do not play back correctly.

Movies recorded with high recording pixels may momentarily stop playing if played on slow reading memory cards.

Images shot with this camera may not play back properly on other cameras.

Reading images from memory card is slow.

Memory card was formatted in another device.

- Use a memory card formatted in your camera (pp. 16, 220).

Battery/Battery Charger

Battery consumed quickly.

Battery is not being used to its full capacity.

- See *Battery* (p. 254).

Battery life exceeded if battery loses its charge quickly at normal temperature (23 °C/73 °F).

- Replace the battery with a new one (p. 11).

Battery will not charge.

Battery life exceeded.

- Replace the battery with a new one (p. 11).

TV monitor output

Image is distorted or not showing on TV monitor.

Incorrect video system setting.	<ul style="list-style-type: none"> ● Set the video system to the appropriate setting, NTSC or PAL, for your TV (p. 61).
Shooting in Stitch Assist mode.	<ul style="list-style-type: none"> ● The output will not appear on a TV in Stitch Assist mode. Shoot in a different shooting mode (p. 102).

Printing with a direct print compatible printer

Cannot print.

The camera and printer are not properly connected.	<ul style="list-style-type: none"> ● Securely connect the camera and printer with the specified cable.
The printer power is not turned on.	<ul style="list-style-type: none"> ● Turn on the printer power.
The print connection method is not correct.	<ul style="list-style-type: none"> ● Select [Print Method] and select [Auto] (p. 61).

List of Messages

The following messages may appear on the LCD monitor during shooting or playback.

Please refer to the *Direct Print User Guide* for the messages that display during a printer connection.

Busy...

Image is being recorded onto the memory card, red eye correction is being processed.

Resetting all the camera and menu settings to default.

No memory card

You turned on the camera without a memory card installed, or with a memory card installed in the wrong orientation (p. 11).

Card locked!

The SD memory card or SDHC memory card is write protected (p. 256).

Cannot record!

You attempted to shoot an image without a memory card installed, with a memory card installed in the wrong orientation, or attempted to attach a sound memo to a movie.

Memory card error

The memory card may be malfunctioning. By formatting the malfunctioning memory card with the camera, you may be able to continue using it (pp. 16, 220). However, if this error message continues to appear, contact your Canon Customer Support Help Desk as there may be a problem with the camera.

Memory card full

Memory card is full of images and no more can be recorded or saved. In addition, no more image settings, or sounds or sound memos can be recorded.

Naming error!

The file name could not be created because there is an image with the same name as the folder that the camera is attempting to create, or the highest possible file number has already been reached. In the Set up menu, set [File Numbering] to [Auto Reset]; alternatively, save all the images you wish to retain onto a computer, then reformat the memory card. Please note that formatting will erase all the existing images and other data.

Change the battery pack.

Battery charge is insufficient to operate the camera. Replace it at once with a charged one or recharge the battery. Also refer to *Battery* (p. 254).

No image.

No images recorded on memory card.

Image too large.

You attempted to play back an image larger than 5616 × 3744 pixels or with a large data size.

Incompatible JPEG

You attempted to play back an incompatible JPEG image (edited with a computer, etc.).

RAW

You attempted to play back a different type of RAW image.

Unidentified Image

You attempted to play back an image with corrupted data, an image with a recording type specific to another manufacturer's camera, or an image that has been downloaded to a computer and altered.

Cannot magnify!

You attempted to magnify an image recorded in a different camera or data type, an image edited with a computer, or a movie.

Cannot rotate

You attempted to rotate the image shot with a different camera or data type, or an image edited with a computer.

Incompatible WAVE

A sound memo cannot be added to this image since the data type of the existing sound memo is incorrect. In addition, sound cannot be played back.

Cannot register this image!

You attempted to register an image recorded in a different camera, a RAW image or a movie as a start-up image.

Cannot modify image

You attempted to add My Colors effects, apply red-eye correction, resize, or apply brightness correction to a movie, RAW image, or image taken with another camera. Or you attempted to resize an image already resized to **XS** or an image shot in **W**. Or, you attempted to trim an image recorded using **W**, or a **S** or **XS** image.

Cannot assign to category

You attempted to categorize an image recorded in a different camera.

Cannot Modify

Cannot apply red-eye correction as no red-eye is detected.

Cannot transfer!

When transferring images to your computer using the Direct Transfer menu, an image with corrupted data, an image taken with a different camera or data type. You may have also attempted to select a movie or a RAW image when [Wallpaper] was selected in the Direct Transfer menu.

Protected!

You attempted to erase or edit a protected image, movie or sound memo.

Too many marks

Too many images have been marked with print settings, transfer settings or slide show image settings. Cannot process any more.

Cannot complete!

Could not save a part of the print, transfer or slide show settings.

Unselectable image

You attempted to set the print settings for a non-JPEG image.

Cannot select

In selecting the image range for categorizing via the My Category function, protecting images, erasing images or specifying print settings, you selected a starting image with a file number higher than the last image or a last image with a file number lower than the starting image. Or, you specified more than 500 images.

Communication error

The computer was unable to download the image due to the large amount of images (approx. 1000) stored on the memory card. Use a USB card reader or a PCMCIA card adapter to download the images.

Lens error, restart camera

An error was detected while the lens was in motion, and the power has been automatically turned off. This error can occur if you hold the lens while it is in motion or you operate it in a location with excessive dust or sand in the air. Try turning the power back on, and resume shooting or playback. If this message continues to display, contact your Canon Customer Support Help Desk as there may be a problem with the lens.

Exx

(xx: number) Camera detected an error. Turn the power off and then back on, then shoot or play back. A problem exists if the error code reappears. Note the number and contact your Canon Customer Support Help Desk. If an error code displays directly after taking a picture, the shot may not have been recorded. Check image in playback mode.

Appendix

Safety Precautions

- Before using the camera, please ensure that you read the safety precautions described below and in the “Safety Precautions” section. Always ensure that the camera is operated correctly.
- The safety precautions noted on the following pages are intended to instruct you in the safe and correct operation of the camera and its accessories to prevent injuries or damage to yourself, other persons and equipment.
- Equipment refers to the camera, battery charger or compact power adapter (sold separately).
- Battery refers to the battery pack.

Warnings

Equipment

- **Do not point the camera at bright light sources (the sun in bright clear skies, etc.).**
 - Doing so could damage the camera's CCD.
 - Doing so can damage your eyesight.
 - **Store this equipment out of the reach of children and infants.**
 - Neck strap: Placement of the strap around the child's neck could result in asphyxiation.
 - Memory card: It may be swallowed accidentally. If this occurs, contact a doctor immediately.
-

-
- **Do not attempt to disassemble or alter any part of the equipment that is not expressly described in this guide.**
 - **To avoid the risk of high-voltage electrical shock, do not touch the flash portion of the camera if it has been damaged.**
 - **Stop operating the equipment immediately if it emits smoke or noxious fumes.**
 - **Do not allow the equipment to come into contact with, or become immersed in, water or other liquids. If the exterior comes into contact with liquids or salt air, wipe it dry with a soft, absorbent cloth.**

Continued use of the equipment may result in fire or electrical shock. Immediately turn the camera power off and remove the camera battery or unplug the battery charger or compact power adapter from the power outlet. Please consult your camera distributor or the closest Canon Customer Support Help Desk.

-
- **Do not use substances containing alcohol, benzine, thinners or other flammable substances to clean or maintain the equipment.**
 - **Do not cut, damage, alter or place heavy items on the power cord.**
 - **Use only recommended power accessories.**
 - **Remove the power cord on a regular periodic basis and wipe away the dust and dirt that collects on the plug, the exterior of the power outlet and the surrounding area.**
 - **Do not handle the power cord if your hands are wet.**

Continued use of the equipment may result in fire or electrical shock.

Battery

- **Do not place the battery near a heat source or expose it to direct flame or heat.**
- **The battery should not be immersed in water or sea water.**
- **Do not attempt to disassemble, alter or apply heat to the battery.**
- **Avoid dropping or subjecting the battery to severe impacts that could damage the casing.**
- **Use only recommended battery and accessories.**

Failure to follow these precautions may cause explosions or leaks, resulting in fire, injury and damage to the surroundings. In the event that a battery leaks and the eyes, mouth, skin or clothing contact these substances, immediately flush with water and seek medical assistance.

- **Disconnect the battery charger and compact power adapter from both the camera and the power outlet after recharging or when not in use to avoid fire and other hazards.**
- **Do not place anything, such as tablecloths, carpets, bedding or cushions, on top of the battery charger while it is charging.**

Leaving the units plugged in for a long period of time may cause them to overheat and distort, resulting in fire.

- **Use only the specified battery charger to charge the battery.**
- **The battery charger and compact power adapter are designed for exclusive use with your camera. Do not use it with other products or batteries.**

There is a risk of overheating and distortion which could result in fire or electrical shock.

- **Before you discard a battery, cover the terminals with tape or other insulators to prevent direct contact with other objects.**

Contact with the metallic components of other materials in waste containers may lead to fire or explosions.

Others

- **Do not trigger the flash in close proximity to human or animal eyes. Exposure to the intense light produced by the flash may damage eyesight.**

In particular, remain at least one meter (39 inches) away from infants when using the flash.

- **Keep objects that are sensitive to magnetic fields (such as credit cards) away from the speaker of the camera.**

Such items may lose data or stop working.

- **When using the optional Tele Converter or Conversion Lens Adapter, be sure to attach them firmly.**

If the lens becomes loose and falls off, it may crack, and the shards of glass may lead to cuts.

Cautions

Equipment

- **Do not get the camera caught on other objects or subject it to strong impacts or shocks when wearing or holding it by the neck strap.**

- **Be careful not to bump or strongly push the end of the lens.**

The above-mentioned could lead to injury or damage the equipment.

- **Be careful not to allow dust or sand into the camera when using it at a beach or place with strong winds.**

Such conditions could lead to damage.

- **Do not store the equipment in humid or dusty areas.**

- **During shooting, do not allow metal objects (such as pins or keys) or dirt to contact the charger terminals or plug.**

Such conditions could lead to fire, electrical shock or other damage.

- **Avoid using, placing or storing the equipment in places subject to strong sunlight or high temperatures, such as the dashboard or trunk (boot) of a car.**

- **Do not use the equipment in a manner that exceeds the rated capacity of the electrical outlet or wiring accessories. Also, do not use the equipment if the cable or plug is damaged, or if the plug is not fully inserted into the power outlet.**

- **Do not use in locations with poor ventilation.**

The above-mentioned can cause leakage, overheating or explosion, resulting in fire, burns or other injuries. High temperatures may also cause deformation of the casing.

- **When not using the camera for extended periods of time, remove the battery from the camera or battery charger and store the equipment in a safe place.**

If the battery is are left inside the camera, damage caused by leakage may occur.

- **Do not connect compact power adapters or battery chargers to devices such as electrical transformers for foreign travel because it may lead to malfunctions, excessive heat generation, fire, electric shock or injury.**

Flash

- **Do not operate the flash with dirt, dust or other items stuck to the surface of the flash.**
- **Be careful not to cover the flash with your fingers or clothing when shooting.**

The flash may be damaged and emit smoke or noise. The resulting heat build-up could damage the flash.

- **Do not touch the surface of the flash after taking several pictures in rapid succession.**

Doing so could result in burns.

Preventing Malfunctions

Camera

Avoid Strong Magnetic Fields

- **Never place the camera in close proximity to electric motors or other equipment generating strong electromagnetic fields.**

Exposure to strong magnetic fields may cause malfunctions or corrupt image data.

Avoid Condensation Related Problems

- **When moving the equipment rapidly from cold to hot temperatures, you can avoid condensation by placing the equipment in an airtight, resealable plastic bag and letting it adjust to temperature changes slowly before removing it from the bag.**

If condensation forms on the camera, remove the memory card and battery, and set the camera aside in room temperature to allow the condensation to naturally evaporate before using the camera again.

Battery

- **Keep the battery terminals clean at all times.**

Dirty terminals may cause poor contact between the battery and camera. Polish the terminals with a soft cotton swab before charging or using the battery.

- **At low temperatures, battery performance may be reduced and the low battery icon  (blinks red) may appear earlier than usual.**

Under these conditions, restore the battery performance by warming it in a pocket immediately before use.

- **Do not put the battery into a pocket together with metallic items such as a key ring.**

The battery may be short circuiting.

- **Do not allow any metal objects such as key rings to touch the (⊕) and (⊖) terminals (Fig. A). To carry the battery or store it during periods of disuse, always replace the terminal cover (Fig.B).**

These conditions can damage the battery. You may be able to check the charge state depending upon how the terminal cover is attached (Fig. C, D).

Fig. A



Fig. B

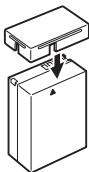
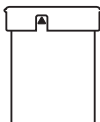

Fig. C

Fully Charged Battery



Attach it so the ▲ is visible.

Fig. D

Used Battery

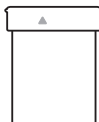

Attach in the opposite way of Fig. C.

- **You are recommended to use it in the camera until it is depleted and to store it in an indoor location with low relative humidity and between the temperatures of 0 – 30 °C (32 – 86 °F).**

Storing a fully charged battery for long periods of time (about one year) may shorten its life cycle or affect its performance. If you do not use the battery for long periods of time, charge it fully and discharge it in the camera about once a year before returning it to storage.

- **Since this is a lithium-ion battery, you need not deplete it before recharging.**
- **You are advised to charge the battery on the day of use, or one day before, to ensure a full charge.**

Even charged batteries continue to discharge naturally.

- It takes approximately 2 hours 20 minutes to fully charge the battery from a depleted state (based on Canon's testing standards).
 - Charging it within a temperature range of 5 – 40 °C (41 – 104 °F) is recommended.
 - Charge times may vary according to the ambient temperature and the battery's charge state.
-
- If the performance of the battery diminishes substantially even when it is fully charged, its life has been exceeded and it should be replaced.
-

Memory Card

- SD Memory Card or SDHC Memory Card Write Protect Tab

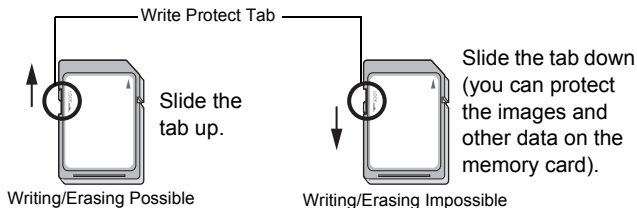

- Memory cards are high-precision electronic devices. Do not bend them, apply force to them, or subject them to shocks or vibration.
 - Do not attempt to disassemble or alter the memory card.
 - Do not allow dirt, water or foreign objects to contact the terminals on the back of the memory card. Do not touch the terminals with your hands or metal objects.
 - Do not peel away the original label on the memory card or cover it with another label or sticker.
 - When writing on the memory card, do not use a pencil or ballpoint pen. Only use a soft point pen (e.g. felt-tip pen).
-

- **Do not use or store memory cards in the following locations.**
 - Locations subject to dust or sand
 - Locations subject to high humidity and high temperatures
- **Since some or all of the data recorded on the memory card may be corrupted or erased by electrical noise, static electricity, camera or memory card malfunction, making a backup copy of important data is recommended.**
- **Please note that formatting (initializing) a memory card erases all data, including protected images.**
- **You are recommended to use memory cards that have been formatted in your camera.**
 - When the camera is malfunctioning, a corrupted memory card might be the cause. Reformatting the memory card may solve the problem.
 - Memory cards formatted in other cameras, computers, or peripheral devices may not operate correctly in this camera. When that happens, reformat the memory card with this camera.
- **If formatting in the camera does not work properly, turn the camera off and re-insert the memory card. Then turn the camera back on and format again.**
- **Be careful when transferring or disposing of a memory card. Formatting or erasing the data on a memory card merely changes the file management information on the memory card and does not ensure that its contents are completely deleted. When disposing of a memory card, take precautions, such as physically destroying the memory card, to prevent personal information leaks.**

LCD Monitor

- **Do not sit in a chair with the camera in your pocket.**

Doing so may cause malfunction or damage the LCD monitor.
- **When putting the camera in your bag, ensure that hard objects do not come into contact with the LCD monitor.**

If this occurs, it may cause malfunction or damage the LCD monitor.
- **Do not attach accessories to the strap.**

Doing so may cause malfunction or damage the LCD monitor.

Using the AC Adapter (Sold Separately)

It is best to power the camera with AC Adapter Kit ACK-DC50 (sold separately) when you are using it for long periods of time or connecting it to a computer.



Turn the camera power off before connecting or disconnecting the AC adapter.

- 1 Connect the power cord to the compact power adapter first and then plug the other end into the power outlet.**

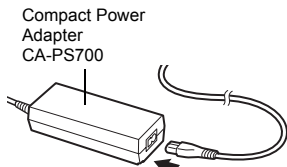

- 2 Connect the DC plug of the compact power adapter cable to the DC Coupler terminal.**

DC Coupler
DR-50

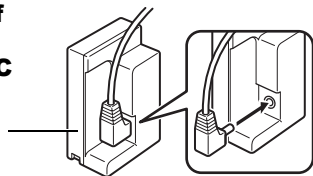

- 3 Open the memory card/battery cover, then insert the DC Coupler until it is locked.**

Battery lock

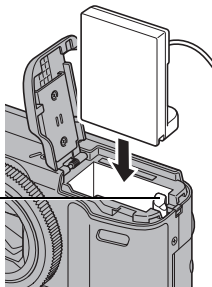

4 Press and hold the DC Coupler cable cover using the cable, then close the memory card/battery cover.

- Always disconnect the compact power adapter from the power supply after use.

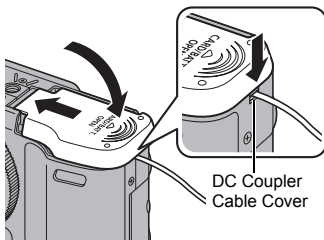

Using the Lenses (Sold Separately)

When attaching the Tele-converter TC-DC58D (each sold separately) you also need the Conversion Lens Adapter LA-DC58K.



- When attaching the tele-converter, be sure to screw it on securely. If they come loose, they may fall from the lens adapter, posing risk of injury from shattered glass.
- Never look into the sun or into strong light through the tele-converter as this can result in blindness or impairment of vision.



- If the built-in flash is used with the lens hood attached, the outer edges of shot images (especially the lower right) may be darkened.
- When using the tele-converter, set the camera near the maximum telephoto. At other zoom settings, the image will appear as if its corners have been cut off.
- If you use the viewfinder for shooting, a portion of the view will be blocked by these attachments. Please use the LCD monitor.

■ Tele-converter TC-DC58D

This lens is used for taking telephoto shots. The lens changes the focal length of the camera body's lens by a factor of 1.4x (the thread diameter is 58 mm).



It is not possible to attach a lens hood or filter to the tele-converter.

■ Conversion Lens Adapter LA-DC58K

This is a lens adapter required for attaching the teleconverter. The adapter can be taken apart into a front and back component, but be sure to use the adapter in its conjoined state when attaching the teleconverter.

Attaching a Lens

- 1 Be sure that the camera is turned off.**
- 2 Press the ring release button (①) and hold it down, and turn the ring in the direction of the arrow (②).**

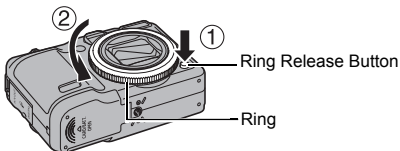

- 3 When the ○ mark on the ring and the ● mark on the camera are aligned, lift off the ring.**

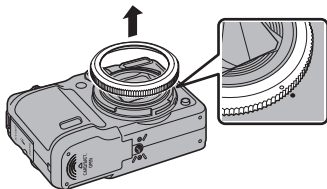

- 4** Align the ● mark on the conversion lens adapter with the ● mark on the camera, and turn the adapter in the direction of the arrows until locked.

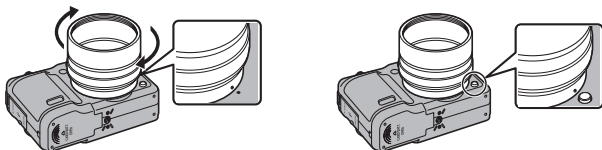

- The conversion lens adapter can be taken apart into a front and back component, but be sure to use the adapter in its conjoined state. Also, make sure that the front and back components are firmly attached to each other before attaching the adapter to the camera.
- To remove the conversion lens adapter, turn the adapter in the opposite direction with holding down the ring release button.

- 5** Set the lens on the adapter, and turn it in the indicated direction to attach it securely.





- Completely remove all dust and dirt from conversion lenses with a lens blower brush before use. The camera may focus on any dirt that remains.
- Be careful when handling the lenses since it is easy to get finger prints on them.
- Be careful not to drop the camera or adapter when removing the ring.
- When using these lens attachments, you should not shoot images in  mode. It will not be possible to use the PhotoStitch software from your computer to accurately stitch the images together.

Converter Settings



Set up when shooting using the [IS Mode] (p. 85) by attaching the Tele-converter TC-DC58D, sold separately.

1 Select [Converter].

1. Press the **MENU** button.
2. In the  menu, use the  or  button to select [Converter].







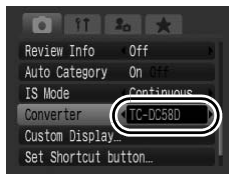

2 Make settings.

1. Use the  or  button to select [TC-DC58D].
2. Press the **MENU** button.



The Icons on the LCD Monitor

[Converter] setting	[IS Mode] setting			
	[Continuous]	[Shoot Only]	[Panning]	[Off]
None				
TC-DC58D				



When you remove the converter from the camera, return the converter setting to [Off].

Changing the Ring Color

You can change the color of the ring using the separately sold Ring Accessory Kit RAK-DC2.

1 Be sure that the camera is turned off.

2 Press the ring release button (①) and hold it down, and turn the ring in the direction of the arrow (②).

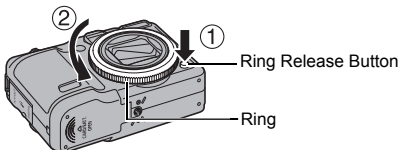

3 When the ○ mark on the ring and the ● mark on the camera are aligned, lift off the ring.

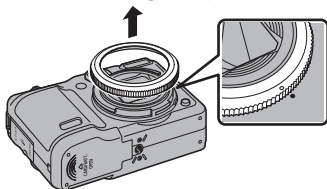

4 Align the ○ mark on the ring with the ● mark on the camera, and then turn the ring in the direction of the arrow.

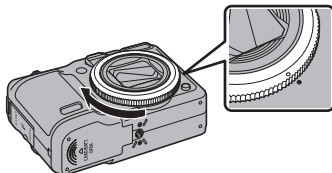

Using an Externally Mounted Flash (Sold Separately)

Available Shooting Modes >> p. 300

You can make your flash photography even clearer and more natural appearing with the use of a separately sold externally mounted flash. The camera's auto exposure function will operate with a Canon Speedlite 220EX, 430EX II, 580EX II, Macro Ring Lite MR-14EX and Macro Twin Lite MT-24EX (except with the **M** mode or when [Flash Mode] is set to [Manual]). Other flashes may fire manually or not fire at all.

Please check the manual for your flash.

You are recommended to set the white balance to .

* Certain functions noted in the manuals for the Canon Speedlite 220EX, 430EX II, 580EX II, Macro Ring Lite MR-14EX and Macro Twin Lite MT-24EX cannot be performed when mounted on this camera. Please read this guide before using one of these flashes on the camera.



- Since the camera's auto exposure function will trigger an externally mounted flash when shooting in **AUTO** or **SCN** mode, settings cannot be changed.
- When using Canon mounted flashes other than the Speedlite EX series, automatic red-eye correction is not available.

Attaching the Externally Mounted Flash

- 1 Attach the flash to the camera's hot shoe.**

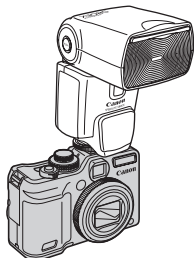

2 Turn the external flash on and turn the camera on.

-  (red) appears on the LCD monitor.

3 Turn the mode dial to the desired mode.

● Speedlite 220EX*

- The maximum flash synchro shutter speed is 1/250 second.
- The flash will automatically adjust its output when [Flash Mode] is set to [Auto].
- When [Flash Mode] is set to [Auto] the flash exposure compensation can be adjusted. When [Flash Mode] is set to [Manual], the flash output can be adjusted (p. 113).
- In **M** mode or when [Flash Mode] is set to [Manual], the output of an externally mounted flash can be adjusted in the flash output adjustment screen (p. 113). For the optimum aperture values and ISO speeds for the distance to the subject, refer to the guide number listed in the flash's user guide (adjustment can be made on the camera only).
You can also adjust the flash output even when the camera is set to the E-TTL automatic flash exposure compensation mode by changing the flash exposure compensation setting.

* You can also use the 380EX, 420EX, 430EX, 550EX and 580EX.

- **Speedlite 430EX II and 580EX II**

- The maximum flash synchro shutter speed is 1/250 second.
- The flash will automatically adjust its output when [Flash Mode] is set to [Auto].
- When [Flash Mode] is set to [Auto] the flash exposure compensation can be adjusted. When [Flash Mode] is set to [Manual], the flash output can be adjusted (p. 113).
- In **M** mode or when [Flash Mode] is set to [Manual], the output of an externally mounted flash can be adjusted in the flash output adjustment screen (p. 113). You can also adjust the flash output from the flash (the flash setting overrides the camera setting when both are set). For the optimum aperture values and ISO speeds for the distance to the subject, refer to the guide number listed in the flash's user guide.
You can also adjust the flash output even when the camera is set to the E-TTL automatic flash exposure compensation mode by changing the flash exposure compensation setting.
- In **M** mode, you can set the flash output with the camera even if the flash unit is set to E-TTL automatic flash exposure compensation. [E-TTL] will display on the flash, but the flash will fire manually.

- **Other Canon Flashes (other than Speedlite EX series, Macro Ring Lite MR-14EX and Macro Twin Lite MT-24EX)**

- Since other flashes fire at full strength, set the shutter speed and aperture accordingly.

4 Press the shutter button halfway.

- The flash is charged when its pilot lamp lights up.

5 Press the shutter button all the way to shoot the image.

Setting the Externally Mounted Flash

1 Display the Flash Settings screen.

1. Hold the  button down for more than one second.

- Before making flash settings, mount the external flash and turn the flash on.
- You can also set in [Flash Control] in the  menu.

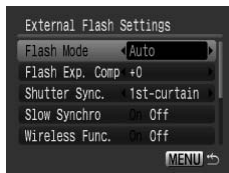

2 Make settings.

1. Use the **▲** or **▼** button to select the items you wish to set.
2. Use the **◀** or **▶** button to set the item.
3. Press the **MENU** button.

- The available settings will vary depending on the flash in use.
For details on settings, refer to the user guide included with your flash or Speedlite Transmitter.

Speedlite 220EX, Macro Ring Lite MR-14EX and Macro Twin Lite MT-24EX Settings * : Default setting.

Item	Options	Shooting mode			
		P	Tv	Av	M
Flash Mode	Auto	<input type="radio"/> *	<input type="radio"/> *	<input type="radio"/> *	—
	Manual	<input type="radio"/>	<input type="radio"/>	<input type="radio"/>	<input type="radio"/> *
Flash Exp.Comp ¹⁾	—3 to +3	<input type="radio"/>	<input type="radio"/>	<input type="radio"/>	—
Flash Output ²⁾	1/64 to 1/1 (in 1/3 steps)	<input type="radio"/>	<input type="radio"/>	<input type="radio"/>	<input type="radio"/>
Shutter Sync.	1st-curtain	<input type="radio"/> *	<input type="radio"/> *	<input type="radio"/> *	<input type="radio"/> *
	2nd-curtain	<input type="radio"/>	<input type="radio"/>	<input type="radio"/>	<input type="radio"/>
Slow Synchro	On	<input type="radio"/>	<input type="radio"/> *	<input type="radio"/>	<input type="radio"/> *
	Off	<input type="radio"/> *	—	<input type="radio"/> *	—
Red-Eye Corr.	On	<input type="radio"/>	<input type="radio"/>	<input type="radio"/>	<input type="radio"/>
	Off	<input type="radio"/> *	<input type="radio"/> *	<input type="radio"/> *	<input type="radio"/> *
Red-Eye Lamp	On	<input type="radio"/> *	<input type="radio"/> *	<input type="radio"/> *	<input type="radio"/> *
	Off	<input type="radio"/>	<input type="radio"/>	<input type="radio"/>	<input type="radio"/>
Safety FE ¹⁾	On	<input type="radio"/> *	<input type="radio"/> *	<input type="radio"/> *	—
	Off	<input type="radio"/>	<input type="radio"/>	<input type="radio"/>	<input type="radio"/> *

: Settings are retained even when the camera power is turned off.

1) This can be set when [Flash Mode] is set to [Auto].

2) This can be set when [Flash Mode] is set to [Manual].

Speedlite 430EX II/580EX II Settings

* : Default setting.

Item	Options	Shooting mode			
		P	Tv	Av	M
Flash Mode 1)	Auto	○*	○*	○*	—
	Manual	○	○	○	○*
Flash Exp. Comp 1) 2)	-3 to +3	○	○	○	—
Flash Output 1) 3)	1/128 4) to 1/1 (in 1/3 steps)	○	○	○	○
Shutter Sync. 1)	1st-curtain	○*	○*	○*	○*
	2nd-curtain	○	○	○	○
	Hi-speed	○	○	○	○
Slow Synchro	On	○	○*	○	○*
	Off	○*	—	○*	—
Wireless Func. 1) 5)	On	○	○	○	○
	Off	○*	○*	○*	○*
Red-Eye Corr.	On	○	○	○	○
	Off	○*	○*	○*	○*
Red-Eye Lamp	On	○*	○*	○*	○*
	Off	○	○	○	○
Safety FE 2)	On	○*	○*	○*	—
	Off	○	○	○	○*
Clear Flash Settings 6)	Resets the settings to their default values.	○	○	○	○

■ : Settings are retained even when the camera power is turned off.

1) The settings from the flash are applied when you turn on the camera.

2) This can be set when [Flash Mode] is set to [Auto].

3) This can be set when [Flash Mode] is set to [Manual].

4) When using Speedlite 430EX II, 1/64 will be set.

5) Only [On] and [Off] can be set with the camera, and further settings are made with the flash (cannot be set with Speedlite 430EX II).

6) [Slow Synchro], [Safety FE], [Red-Eye Corr.] and [Red-Eye Lamp] can also be returned to their default values using [Reset All] in the camera's  menu (p. 227).



- [Flash Control] will not display when the flash is turned off. Before making flash settings, turn the flash on.
- When an external flash is mounted, you cannot make built-in flash settings.
- When adjusting flash exposure compensation with the camera, set the external flash's exposure compensation to [+0].
- If the external flash has been set to stroboscopic flash, the flash's set up menu cannot be selected (580EX II only).
- When [Wireless Func.] is set to [On], [Shutter Sync.] cannot be set to [2nd-curtain]. Even if you set [Shutter Sync.] to [2nd-curtain] with the camera, it will change to [1st-curtain].
- For continuous shooting, the flash can be in quick flash mode (pilot lamp lit green). In this case, light emission may be smaller than with full flash (pilot lamp lit red).
- The focus bracketing mode and the AEB mode cannot be used for flash photography. If the flash fires, only one image gets recorded.
- Flashes (especially high-voltage flashes) or flash accessories made by other manufacturers may override certain camera functions or cause a camera malfunction.



- The following functions can be used with a Speedlite 220EX, 430EX II or 580EX II*.
 - Auto Exposure (Use the E-TTL mode with a 430EX II or 580EX II)
 - FE Lock (Not available in **M** mode or when [Flash Mode] is [Manual])
 - Shutter Sync. (1st-curtain/2nd-curtain) (2nd-curtain priority with Speedlite 430EX II)
 - Slow Synchro
 - Flash Exp. Comp
 - Auto Zoom (Not available with the 220EX)
 - Manual flash
 - High-speed sync

* You can also use 380EX, 420EX, 430EX, 550EX and 580EX.

Using a Supplementary Flash (Sold Separately)

High-Power Flash HF-DC1

This flash is used to supplement the camera's built-in flash when the subject is too far away for proper illumination. Use the following procedures to affix the camera and High-Power Flash to the supporting bracket.

Please read the instructions accompanying the flash along with this explanation.

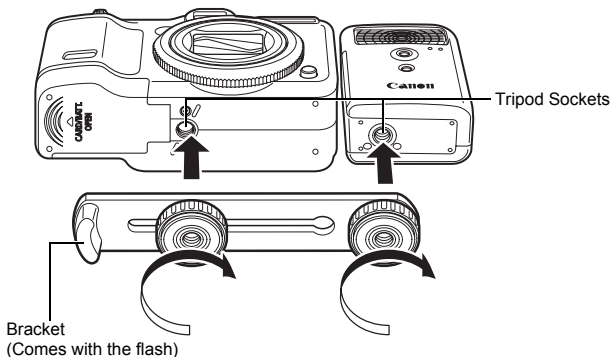

- The High-Power Flash will not fire under the following circumstances.
 - When shooting in **M** mode
 - When [Shutter Sync.] is on [2nd-curtain]
 - When [Flash Mode] is on [Manual] (p. 113)
- The flash charge time will lengthen as the battery charge gets weaker. Always set the power/mode switch to off when you finish using the flash.
- Be careful not to touch the flash window or sensor windows with your fingers while the flash is in use.

- The flash may fire if another flash is being used in close proximity.
- The High-Power Flash may not fire outdoors in daylight or when there are no reflective items.
- For continuous shooting, although the flash fires for the first shot, it does not fire for subsequent shots.
- Fasten the attachment screws securely so that they do not loosen. Failure to do so may lead to the dropping of the camera and flash resulting in damage to both.



- Before attaching the bracket to the flash, check that the lithium battery (CR123A or DL123) is installed.
- To illuminate the subjects properly, install the flash so that it is up against the side of the camera and parallel with the camera's front panel.
- A tripod can be used even when the flash is attached.

Batteries

- Charge becomes Severely Limited

If the battery usage time has considerably diminished, wipe the battery terminals well with a dry cloth. The terminals may be dirty from fingerprints.

- Usage in Cold Temperatures

Get a spare generic lithium battery (CR123A or DL123). You are recommended to place the spare battery in your pocket to warm it up before switching it for the battery in the flash.

- Non-Use over Extended Periods

Leaving batteries in the High-Power Flash could allow the battery fluid to leak, damaging the product. Remove the batteries from the High-Power Flash and store them in a cool, dry place.

Using the Remote Switch (Sold Separately)

By using the RS60-E3 Remote Switch (sold separately), you can avoid any camera shake that may occur when you press the shutter button. The remote switch is also useful when using slow shutter speeds. Be sure to stabilize the camera by using a tripod, for example, when using the remote switch. Also, be sure to read the operating instructions supplied with the remote switch before use.

1 Make sure the camera is turned off.

2 Connect the remote switch.

1. Open the terminal cover.
2. Insert the remote switch's plug.

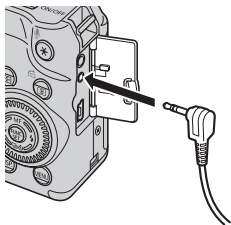

3 Press the release button on the remote switch to shoot.



Bulb photographs cannot be taken with this camera.

Camera Care and Maintenance



Never use thinners, benzine, detergents or water to clean the camera. These substances may distort or damage the equipment.

Camera Body

Gently wipe dirt off the camera body with a soft cloth or eyeglass lens wiper.

Lens

First use a lens blower brush to remove dust and dirt, then remove any remaining dirt by wiping the lens lightly with a soft cloth.



Never use organic solvents on the camera body or lens. If dirt remains, contact the closest Canon Customer Support Help Desk as listed on the separate customer support list supplied with your camera.

Viewfinder and LCD Monitor

Use a lens blower brush to remove dust and dirt. If necessary, gently wipe with a soft cloth or an eyeglass lens wiper to remove stubborn dirt.



Never rub or press strongly on the LCD monitor. These actions may damage it or lead to other problems.

Specifications

All data is based on Canon's standard testing methods. Product specifications and appearance are subject to change without notice, at our sole discretion.

PowerShot G10 (W): Max. wide angle (T): Max. telephoto

Camera Effective Pixels	: Approx. 14.7 million
Image Sensor	: 1/1.7-inch type CCD (Total number of pixels: Approx. 15.0 million pixels)
Lens	: 6.1 (W) – 30.5 (T) mm (35mm film equivalent: 28 (W) – 140 (T) mm) f/2.8 (W) – f/4.5 (T)
Digital Zoom	: Approx. 4.0x (Up to approx. 20x in combination with the optical zoom)
Optical Viewfinder	: Real-image zoom viewfinder Picture coverage approx. 77% (representative value) Eyepoint: 15 mm (0.59 in.) Dioptric adjustment: -3.0 to $+1.0$ m ⁻¹ (dpt)
LCD Monitor	: 3.0-inch type, TFT color LCD (Pure Color LCD II), 461,000 dots, picture coverage 100%
AF System	: TTL autofocus (continuous/single) AF lock and manual focus are available AF frame mode: Face Detect* ¹ * ² / AiAF (9-point)* ³ /Center/FlexiZone* ³ * ¹ AF frame can be moved and fixed to specified face. * ² If no face is detected, AiAF (9-point) is used. * ³ AF frame size can be selected.
Focusing Range (From the end of the lens)	: Normal: 50 cm (1.6 ft.) – infinity Macro: 1 – 50 cm (W) (0.39 in. – 1.6 ft. (W))/ 30 – 50 cm (T) (12 in. – 1.6 ft. (T)) Manual focus: 1 cm (0.39 in.) – infinity (W)/ 30 cm (12 in.) – infinity (T) Sports mode: 1 m (3.3 ft.) – infinity (W)/ 2 m (6.6 ft.) – infinity (T) Kids&Pets: 1 m (3.3 ft.) – infinity

Shutter	: Mechanical shutter + electronic shutter
Shutter Speeds	: 1/60 – 1/4000 sec. 15 – 1/4000 sec. (Total shutter speed range) • Slow shutter speeds of 1.3 sec. or slower operate with noise reduction.
Image Stabilization	: Lens-shift type Continuous/Shoot Only*/Panning*/Off * Still images only.
Metering System	: Evaluative*, Center-weighted average or Spot** * Facial brightness is also evaluated in Face Detect AF. ** Fixed to center/AF-point
Exposure Compensation	: ± 2 stops in 1/3-stop increments
ISO Speed (Standard Output Sensitivity, Recommended Exposure Index)	: Auto*, High ISO Auto*, ISO 80/100/200/400/800/1600 * Camera automatically sets the optimal speed.
ND Filter (built-in)	: Light intensity reduction: 3 stops (Intensity becomes 1/8 of actual level)
White Balance	: Auto*, Day Light, Cloudy, Tungsten, Fluorescent, Fluorescent H, Flash, Underwater, Custom 1 or Custom 2 * The colors of faces are evaluated in Face Detect AF.
Built-in Flash	: Auto, on, off Flash output compensation (± 2.0 stops in 1/3-stop increments), Red-Eye Correction, Red-Eye Reduction, flash output settings (3 steps), FE Lock, Slow Synchro, 2nd-curtain Synchro and Safety FE are available. • Facial brightness is also evaluated in Face Detect AF.
Built-in Flash Range	: 30 cm – 4.6 m (12 in – 15 ft.) (W)/50 cm – 2.8 m (1.6 – 9.2 ft.) (T) • Brightness of image periphery may reduce depending on shooting distance.

External Flash	: Flash output compensation (± 2.0 stops in 1/3-stop increments), Red-Eye Correction, Red-eye Reduction, flash output settings (19 levels*), FE Lock, Slow Synchro, 2nd-curtain Synchro, High-Speed Sync, Safety FE and wireless flash (On/Off only) are available. * 22 levels with 580EX II
Terminals for External Flash	: Hot shoe flash-sync contacts Use of the following external flashes is recommended: Canon Speedlite 220EX, 430EX II, 580EX II, Macro Ring Lite MR-14EX and Macro Twin Lite MT-24EX.
Shooting Modes	: Auto Creative zone: P Program, Tv Shutter-speed priority, Av Aperture priority, M Manual, C1 Custom 1, C2 Custom 2 Image zone: Special Scene*, Stitch Assist, Movie** * Portrait, Landscape, Night Scene, Sports, Night Snapshot, Kids&Pets, Indoor, Sunset, Foliage, Snow, Beach, Fireworks, Aquarium, Underwater, ISO 3200, Color Accent and Color Swap. ** Standard, Color Accent and Color Swap.
Continuous Shooting	: Approx. 1.3 shots/sec. Approx. 0.7 shots/sec. (Continuous Shooting AF) Approx. 0.7 shots/sec. (Continuous Shooting LV) • Under the conditions where the flash does not fire automatically.
Self-timer	: Self-timer: Approx. 10-sec./approx. 2-sec. delay, custom or FaceSelf-timer
Remote Shooting (PC)	: Shooting possible when connected to a computer using supplied software.
Remote Switch	: Connecting possible (RS60-E3)
Recording Media	: SD memory card/SDHC memory card/MultiMediaCard/MMCplus card/HC MMCplus card

File Format	: Design rule for camera file system and DPOF compliant
Data Type	: Still images: Exif 2.2 (JPEG)*/RAW (CR2)** : Movies: MOV (Image data: H.264; Audio data: Linear PCM (monaural)) : Sound Memo and Sound Recorder: WAVE (monaural) * This digital camera supports Exif 2.2 (also called "Exif Print"). Exif Print is a standard for enhancing the communication between digital cameras and printers. By connecting to an Exif Print-compliant printer, the camera's image data at the time of shooting is used and optimized, yielding extremely high quality prints. ** Use Digital Photo Professional to process these files.
Compression	: Superfine, Fine, Normal
Number of (Still images)	: Large : 4416 × 3312 pixels
Recording	Medium 1 : 3456 × 2592 pixels
Pixels	Medium 2 : 2592 × 1944 pixels
	Medium 3 : 1600 × 1200 pixels
	Small : 640 × 480 pixels
	Widescreen : 4416 × 2480 pixels
	RAW : 4416 × 3312 pixels
(Movies)	: Standard, Color Accent and Color Swap : 640 × 480 pixels (30 frames/sec.) : 320 × 240 pixels (30 frames/sec.) Recording can continue until the memory card is full (can record up to a maximum of 4 GB* at one time) * Even if the file size has not reached 4 GB, the recording is stopped when the recording time reaches one hour. Depending on memory card capacity and data write speed, recording may stop before the file size reaches 4 GB or the recording time reaches one hour.

Audio	: Quantization Bit Rate: 16 bit Sampling Rate Sound Memos: 11.025 kHz Movies: 44.100 kHz Sound Recorder: 11.025 kHz/22.050 kHz/ 44.100 kHz
Playback Modes	: Single (histogram displayable), Index (9 images), Magnified (approx. 2x to 10x max.), Resume Playback, Image Inspection Tool, Jump, My Category, Trimming, Movie Playback (editing/slowmotion playback possible), Rotate, Slide Show, Red-Eye Correction, i-Contrast, My Colors, Resize, Sound Memos (recording/playback up to 1 min.), Sound Recorder (up to 2 hours sound-only recording/playback possible) or Protect.
Direct Print	: PictBridge compliant, and Canon Direct Print and Bubble Jet Direct compatible
My Camera Settings	: Start-up image, start-up sound, operation sound, self-timer sound, and shutter sound.
Interface	: Hi-Speed USB (mini-B) Audio/Video output (NTSC or PAL selectable, monaural audio)
Communication Settings	: MTP, PTP
Power Source	: Battery Pack NB-7L (Rechargeable lithium-ion battery) AC Adapter Kit ACK-DC50
Operating Temperatures	: 0 – 40 °C (32 – 104 °F)
Operating Humidity	: 10 – 90%
Dimensions (excluding protrusions)	: 109.1 × 77.7 × 45.9 mm (4.30 × 3.06 × 1.81 in.)
Weight (camera body only)	: Approx. 350 g (12.3 oz.)

Battery Capacity (Battery Pack NB-7L (Fully charged))

Number of Images Shot		Playback Time
LCD Monitor On Playback Time (Based on the CIPA standard)	LCD Monitor Off	
Approx. 400 images	Approx. 1000 images	Approx. 10 hours

- The actual figures will vary according to the shooting conditions and settings.
- Movie data is excluded.
- At low temperatures, the battery performance may diminish and the low battery icon may appear very rapidly. In these circumstances, the performance can be improved by warming the battery in a pocket before use.

Test Conditions

Shooting: Normal temperature (23 °C ±2 °C/73 °F ±3.6 °F), normal relative humidity (50% ±20%), alternating wide angle end and telephoto end shots at 30 second intervals with the flash fired once every two shots and the camera power turned off after every tenth shot. Power is left off for a sufficient amount of time*, then the power is turned back on and the testing procedure is repeated.

* Until the battery returns to normal temperature



















Playback: Normal temperature (23 °C ±2 °C/73 °F ±3.6 °F), normal relative humidity (50% ±20%), continuous playback at 3 seconds per image.



See *Battery* (p. 254).



Memory Cards, Estimated Capacities and Image Data Sizes (Estimated)

Still Image

Recording Pixels	Compression	Capacity	2 GB	8 GB
L (Large) 4416 × 3312 pixels		6348	306	1227
		3759	516	2063
		1797	1059	4234
M1 (Medium 1) 3456 × 2592 pixels		3888	499	1996
		2302	841	3364
		1100	1707	6822
M2 (Medium 2) 2592 × 1944 pixels		2503	767	3069
		1395	1365	5457
		695	2672	10679
M3 (Medium 3) 1600 × 1200 pixels		1002	1862	7442
		558	3235	12927
		278	6146	24562
S (Small) 640 × 480 pixels		249	6830	27291
		150	10245	40937
		84	15368	61406
W (Widescreen) 4416 × 2480 pixels		4753	409	1637
		2814	690	2759
		1345	1396	5581
RAW (RAW) 4416 × 3312 pixels	—	18793	94	378
RAW + L 4416 × 3312 pixels	—	22552	79	318

This reflects standard shooting criteria established by Canon. Actual results may vary according to the subject and shooting conditions.

Movie ((Standard), (Color Accent), (Color Swap))

Recording Pixels/ Frame Rate	Capacity	2 GB	8 GB
 640 × 480 pixels 30 frames/sec.	1316 KB	23 min. 49 sec.	1 hr. 35 min. 11 sec.
 320 × 240 pixels 30 frames/sec.	394 KB	1 hr. 13 min. 10 sec.	4 hrs. 52 min 24 sec.

The figures indicate the maximum continuous recording time.

Depending on the memory card, recording may stop even if the max. clip length has not been reached. Use of SD Speed Class 4 or higher memory cards is recommended.

Sound Recorder Data Rates and Recording Durations (Estimated)

	Sound Size	2 GB	8 GB
11.025 kHz	22 KB/sec.	25 hrs. 22 min. 35 sec.	101 hrs. 23 min. 47 sec.
22.050 kHz	44 KB/sec.	12 hrs. 41 min. 18 sec.	50 hrs. 41 min. 53 sec.
44.100 kHz	88 KB/sec.	6 hrs. 20 min. 39 sec.	25 hrs. 20 min. 57 sec.

Battery Pack NB-7L

Type	Rechargeable lithium-ion battery
Nominal Voltage	7.4 V DC
Typical Capacity	1050 mAh (min.)
Battery Life (Charge Cycles)	Approx. 300 times
Operating Temperatures	0 – 40 °C (32 – 104 °F)
Dimensions	32.5 × 45.4 × 17.7 mm (1.28 × 1.79 × 0.70 in.)
Weight	Approx. 47 g (1.7 oz.)



USA and Canada only:

The Lithium ion/polymer battery that powers the product is recyclable.

Please call 1-800-8-BATTERY for information on how to recycle this battery.

Battery Charger CB-2LZ/CB-2LZE

Rated Input	100 – 240 V AC (50/60 Hz) 0.14 A (100 V) – 0.08 A (240 V) 14 VA (100 V) – 19.2 VA (240 V)
Rated Output	8.4 V DC, 0.70 A
Charging Time	Approx. 2 hrs. 20 min. (for Battery Pack NB-7L)
Operating Temperatures	0 – 40 °C (32 – 104 °F)
Dimensions	92.5 × 27.0 × 62.0 mm (3.64 × 1.06 × 2.44 in.)
Weight	Approx. 92 g (3.2 oz.) (CB-2LZ) Approx. 85 g (3.0 oz.) (CB-2LZE) (excluding the power cord)

Compact Power Adapter CA-PS700

(Included with the separately sold AC Adapter Kit ACK-DC50)

Rated Input	100 – 240 V AC (50/ 60 Hz)
Rated Output	7.4 V DC, 2.0 A
Operating Temperatures	0 – 40 °C (32 – 104 °F)
Dimensions	112.0 × 29.0 × 45.0 mm (4.41 × 1.14 × 1.77 in.) (body only)
Weight	Approx. 185 g (6.53 oz.) (excluding power cord)

When connecting to and using a household power outlet, use only AC Adapter Kit ACK-DC50 (rated input: 100 – 240 V AC 50/60 Hz, rated output: 7.4 V DC). Using anything else can cause fire, overheating, or electrical shock.

Tele-converter TC-DC58D (Sold Separately)

Magnification	1.4x
Focal Length* ¹	196 mm (35mm film equivalent)
Focusing Range* ¹	55 cm (1.8 ft.) – infinity (T)* ²
Thread Diameter	58 mm standard filter thread
Dimensions Diameter × Length	69.0 × 41.2 mm (2.72 × 1.62 in.)
Weight	Approx. 140 g (4.94 oz.)

Conversion Lens Adapter LA-DC58K (Sold Separately)

Thread Diameter	58 mm standard filter thread
Dimensions Diameter × Length	63.8 × 51.6 mm (2.51 × 2.03 in.)
Weight	Approx. 30 g (1.06 oz.)

(T): Max. telephoto

*1 When mounted on PowerShot G10 (Max. telephoto)

*2 From front of the mounted conversion lens during normal shooting.

*3 Conversion Lens Adapter LA-DC58K is required when mounted on PowerShot G10.

Bracket BKT-DC1 (Sold Separately)

Dimensions	220.0 × 32.0 × 19.0 mm (8.66 × 1.26 × 0.75 in.)
Weight	Approx. 90 g (3.2 oz.)

Index

Numerics

3:2 Guide 66

A

AE Lock) 134

AEB Mode 139

AF Assist Beam 40

AF Frame 49, 121

AF Lock 128

AF Mode 120

AF-assist Beam 56

AF-Point Zoom 116

Aperture Value 97, 98, 100

Aquarium 93

Audio 108

Auto Category 154

Auto ISO Shift 88

Auto Mode 17

Auto Rotate 225

Av 98

B

Battery

 Battery Capacity 281

 Battery Charge Indicator 50

 Charging 10

 Installing 11

Beach 93

Bracket 290

C

C1 109

C2 109

Camera Shake Warning 49, 235

Category

 Auto Category 154

 My Category 165

Clock Display 46

Color Accent 94, 149

Color Swap 94, 151

Components Guide 40

Compression 81

Computer

 Connecting 29

 Downloading Images 28

 System Requirements 27

Continuous Shooting 111

Control Dial 43

Create Folder 223

Custom Display 66

Custom Settings 109

D

Date/Time 14

Digital Photo Professional
..... 82, 279

Digital Tele-Converter 69

Digital Zoom 69

Direct Print Compatible Printer . 38

Direct Transfer 31

Display Language 15

Distance Units 60

DPOF Print Settings 207

DPOF Transfer Settings 214

E

Erase 202

Erasing 20

Externally Mounted Flash 265

F

Face Detect	121
Face Select and Track	125
FE Lock	136
File Numbering	221
Fireworks	93
Flash	
Flash Exp. Comp	113
Settings	113
Shooting	73
Focus	118, 121, 161
Focus Check	64, 118
Focus Check Display	161
Focus Lock	128
Focus Settings	120
Focus-BKT Mode	133
Foliage	93
Frame Rate	107
FUNC. Menu	54
Functions Available in Each Shooting Mode	300

G

Grid Lines	66
------------------	----

H

High-Power Flash	272
Histogram Function	52

I

i-Contrast	138, 187
Image Stabilizer	85
Image Type	82
Index Playback	160
Indicator	42, 45
Indoor	92
ISO 3200	94
ISO Speed	87

J

Jump	163
------------	-----

K

Kids&Pets	92
-----------------	----

L

Landscape	91
LCD Monitor Brightness	65
Lens	
Conversion Lens Adapter ...	261
Tele-converter	260
Lens Retract	60
Lense	260
List of Messages	244

M

M	100
Macro	74
Manual Focus	130
Memory Card	
Estimated Capacities	282
Format	16, 220
Menu	
Play Menu	57
Print Menu	58
Rec. Menu	55
Set up Menu	59
Setting	47
Metering Mode	141
MF-Point Zoom	56, 130
Microphone	24
Microphone Level	108
Mode Dial	90
Movie	
Editing	173
Shooting	24, 104
Viewing	26, 171
Mute	59

My Camera Settings	230
Changing	230
Registering	231
My Category	165
My Colors	146
My Colors (Playback)	189
My Menu	157

N

ND Filter	140
Neck Strap	13
Night Display	65
Night Scene	92
Night Snapshot	92

O

Optional Accessory	36
Overexposure Warning	52

P

P	95
Playback Button	44
Portrait	91
Power Saving	60, 216
Power Source	
AC Adapter Kit	258
Press Fully	18
Press Halfway	17, 25
Print List	23
Print Method	61
Print/Share Button	42
Printing	21
Program AE	95
Protect	197

R

RAW	82
Rec. Review	18
Recording Functions	108

Recording Pixels	80, 107
Red-Eye Corr. (Shooting)	114
Red-Eye Correction (Playback)	
.....	182
Red-Eye Lamp	114
Registering Settings	155
Reset All	227
Resize	192
Resume	19, 57
Resume Playback	19
Review	56
Review Info	118
Rotate	175

S

Safety FE	114
Safety MF	131
Safety Shift	97
Safety Zoom	70
Self-Timer	75
Servo AF	127
Shooting Mode	90
Shortcut Button	155
Shutter Button	17, 24
Shutter Speed	96
Slide Shows	177
Snow	93
Sound Memo	194
Sound Recorder	195
Sports	92
Stitch Assist	102
Sunset	92
System Map	34

T

Telephoto	68, 69
The LCD Monitor Display	63
Time and Date	
Clock Display	46
Time Zone	217

Transition	176
Trimming	168
Tv	96
TV Set	228

U

Underwater	93
------------------	----

V

Video System	61
Volume	59

W

White Balance	143
Wide Angle	68
Wind Filter	108
World Clock	217

Addendum

Attaching an Externally Mounted Flash (for Macro Ring Lite MR-14EX or Macro Twin Lite MT-24EX)

The Conversion Lens Adapter LA-DC58K, Off Camera Shoe Cord OC-E3, and Bracket BKT-DC1 (all sold separately) are required to attach the Macro Ring Lite MR-14EX or Macro Twin Lite MT-24EX to the camera. Please read the instructions accompanying the flash and Off Camera Shoe Cord along with this explanation.

1 Detach the front component of the conversion lens adapter from the back component.

- The LA-DC58K can be separated into front and back components. Normally, both components are used in their attached state. However, only the back component is attached to the camera when attaching the Macro Ring Lite MR-14EX or Macro Twin Lite MT-24EX.

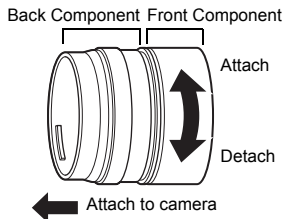

2 Be sure that the camera is turned off.

- 3** Press the ring release button (①) and hold it down, and turn the ring in the direction of the arrow (②).

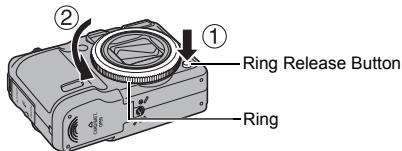

- 4** When the ○ mark on the ring and the ● mark on the camera are aligned, lift off the ring.

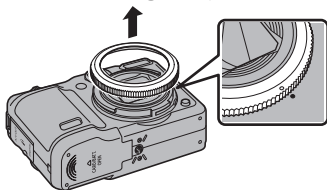

- 5** Align the ● mark on the conversion lens adapter with the ● mark on the camera, and turn the adapter in the direction of the arrows until locked.

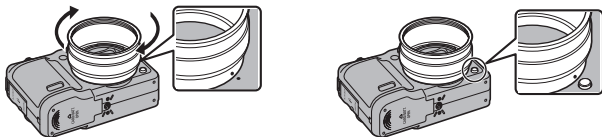

- To remove the conversion lens adapter, turn the adapter in the opposite direction while holding down the ring release button.

6 Attach the Off Camera Shoe Cord to the bracket.

- Slide the bracket screw to the outer end of the bracket, and secure the screw into the tripod socket on the Off Camera Shoe Cord. Be sure to attach the cord and bracket as shown.

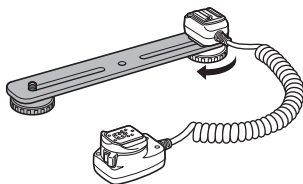

7 Attach the camera to the bracket.

- Slide the bracket screw to the outer end of the bracket, and secure the screw into the tripod socket on the bottom of the camera. Be sure to attach the camera so that the lens faces as shown.

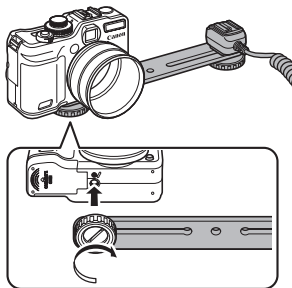

- 8** Attach the camera connection component of the Off Camera Shoe Cord to the hot shoe on the top of the camera.

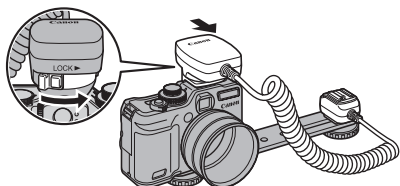

- 9** Attach the controller for the Macro Ring Lite or Macro Twin Lite to the flash connection component of the Off Camera Shoe Cord.

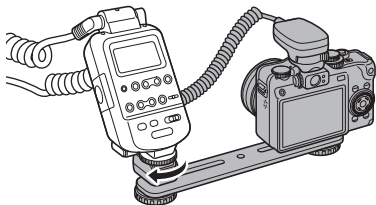

10

Attach the Macro Ring Lite or Macro Twin Lite to the conversion lens adapter.

Macro Ring Lite MR-14EX

- Press and hold the release buttons on both sides of Macro Ring Lite MR-14EX and fit it onto the conversion lens adapter.

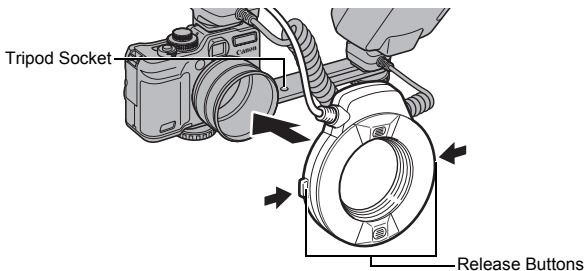

Macro Twin Lite MT-24EX

- Attach the flash heads to their respective flash head mounts.

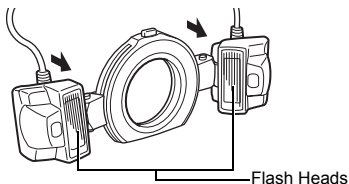

- Press and hold the release button on the top of the external ring and fit it onto the conversion lens adapter.

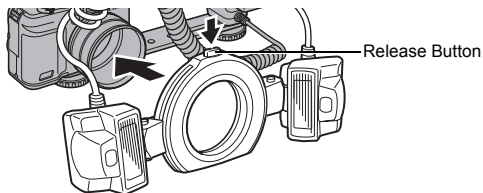

- You can also attach a tripod and shoot. If the flash heads contact the tripod or bracket, adjust the direction of the camera.

11 Turn the mode dial to the desired mode.

- The maximum flash synchro shutter speed is 1/250 second.
- The flash will automatically adjust its output when [Flash Mode] is set to [Auto].
- When [Flash Mode] is set to [Auto] the flash exposure compensation can be adjusted. When [Flash Mode] is set to [Manual], the flash output can be adjusted (p. 113).
- When exposure compensation settings are selected on both the camera and the flash (when in E-TTL mode), the settings on the flash takes precedence and the camera setting is overridden.
- In **M** mode or when [Flash Mode] is set to [Manual], the output of an externally mounted flash can be adjusted in the flash output adjustment screen (p. 113). For the optimum aperture values and ISO speeds for the distance to the subject, refer to the guide number listed in the flash's user guide (the flash's setting takes precedence). When making adjustments using the flash-side controls, set the flash to manual mode. You can also adjust the flash output even when the camera is set to the E-TTL automatic flash exposure compensation mode by changing the flash exposure compensation setting.

12 Press the button, use the **←** or **→** button to select macro mode, and then set [ND Filter] to [On].

- Macro mode (p. 74)
- ND filter (p. 140)

13 Configure the externally mounted flash (p. 268).

- The items that can be configured are the same as those for Speedlite 220EX.



Be sure that the cords from the Off Camera Shoe Cord, Macro Ring Lite or Macro Twin Lite do not obstruct or interfere with the flash.



- When you are using Macro Ring Lite MR-14EX or Macro Twin Lite MT-24EX, you can shoot in E-TTL automatic flash exposure compensation mode just by setting the camera's shooting mode to **P**, **Av** or **Tv**. You are recommended to set the aperture in **Av** or **M** mode for full-fledged macro flash photography.
- The following functions can be used with Macro Ring Lite MR-14EX or Macro Twin Lite MT-24EX mounted.
 - E-TTL Automatic Flash Exposure Compensation
 - FE Lock
 - Shutter Sync. (1st-curtain/2nd-curtain) (The flash's 2nd-curtain setting takes precedence.)
 - Slow Synchro
 - Flash Exp. Comp
- When exposure compensation settings are selected on both the camera and the Macro Ring Lite MR-14EX or Macro Twin Lite MT-24EX, the flash's settings takes precedence (when in E-TTL mode) and the camera setting is overridden.

FCC Notice

(Digital Camera, Model PC1305 Systems)

This device complies with Part 15 of the FCC Rules. Operation is subject to the following two conditions;

- (1) this device may not cause harmful interference, and
- (2) this device must accept any interference received, including interference that may cause undesired operation.

Note: This equipment has been tested and found to comply with the limits for Class B digital devices, pursuant to Part 15 of the FCC rules. These limits are designed to provide reasonable protection against harmful interference in a residential installation. This equipment generates, uses and can radiate radio frequency energy and, if not installed and used in accordance with the instructions, may cause harmful interference to radio communications. However, there is no guarantee that interference will not occur in a particular installation. If this equipment does cause harmful interference to radio or television reception, which can be determined by turning the equipment off and on, the user is encouraged to try to correct the interference by one or more of the following measures:

- Reorient or relocate the receiving antenna.
- Increase the separation between the equipment and receiver.
- Connect the equipment into an outlet on a circuit different from that to which the receiver is connected.
- Consult the dealer or an experienced radio/TV technician for help.

The cable with the ferrite core provided with the digital camera must be used with this equipment in order to comply with Class B limits in Subpart B of Part 15 of the FCC rules.

Do not make any changes or modifications to the equipment unless otherwise specified in the manual. If such changes or modifications should be made, you could be required to stop operation of the equipment.

Canon U.S.A., Inc.

One Canon Plaza, Lake Success, NY 11042, U.S.A.

Tel No. (516) 328-5600

Canadian Radio Interference Regulations

This Class B digital apparatus complies with Canadian ICES-003.

Réglementation canadienne sur les interférences radio

Cet appareil numérique de la classe B est conforme à la norme NMB-003 du Canada.

Battery Charger CB-2LZ

This product is not intended to be serviced. Should the product cease to function in its intended manner, it should be returned to the manufacturer or be discarded.

This power unit is intended to be correctly orientated in a vertical or floor mount position.

IMPORTANT SAFETY INSTRUCTIONS-SAVE THESE INSTRUCTIONS.**DANGER-TO REDUCE THE RISK OF FIRE OR ELECTRIC SHOCK, CAREFULLY FOLLOW THESE INSTRUCTIONS.**

For connection to a supply not in the U.S.A., use an attachment plug adapter of the proper configuration for the power outlet.

This battery charger is for exclusive use with Battery Pack NB-7L (1.05 Ah). There is a danger of explosion if other battery packs are used.

Disclaimer

- While every effort has been made to ensure that the information contained in this guide is accurate and complete, no liability can be accepted for any errors or omissions.
- Canon reserves the right to change the specifications of the hardware and software described herein at anytime without prior notice.
- No part of this guide may be reproduced, transmitted, transcribed, stored in a retrieval system, or translated into any language in any form, by any means, without the prior written permission of Canon.
- Canon makes no warranties for damages resulting from corrupted or lost data due to a mistaken operation or malfunction of the camera, the software, SD memory cards (SD cards), personal computers, peripheral devices, or use of non-Canon SD cards.

Trademark Acknowledgments

- The SDHC logo is a trademark.

About MPEG-4 Licensing

"This product is licensed under AT&T patents for the MPEG-4 standard and may be used for encoding MPEG-4 compliant video and/or decoding MPEG-4 compliant video that was encoded only (1) for a personal and non-commercial purpose or (2) by a video provider licensed under the AT&T patents to provide MPEG-4 compliant video. No license is granted or implied for any other use for MPEG-4 standard."

* Notice displayed in English as required.

Function		Shooting Mode						
		C1	C2	M	Av	Tv	P	AUTO
AF Frame Size (p. 124)	Standard	<input type="checkbox"/>	<input type="checkbox"/>	<input type="radio"/>	<input type="radio"/>	<input type="radio"/>	<input type="radio"/>	<input type="radio"/>
	Small	<input type="checkbox"/>	<input type="checkbox"/>	<input type="radio"/>	<input type="radio"/>	<input type="radio"/>	<input type="radio"/>	<input type="checkbox"/>
Face Select and Track (p. 125)	Off	<input type="checkbox"/>	<input type="checkbox"/>	<input type="radio"/>	<input type="radio"/>	<input type="radio"/>	<input type="radio"/>	<input type="radio"/>
	On	<input type="checkbox"/>	<input type="checkbox"/>	<input type="radio"/>	<input type="radio"/>	<input type="radio"/>	<input type="radio"/>	<input type="radio"/>
Flash (p. 73)	Auto	<input type="checkbox"/>	<input type="checkbox"/>	<input type="checkbox"/>	<input type="checkbox"/>	<input type="checkbox"/>	<input type="checkbox"/>	<input type="radio"/>
	On	<input type="checkbox"/>	<input type="checkbox"/>	<input type="radio"/>	<input type="radio"/>	<input type="radio"/>	<input type="radio"/>	<input type="checkbox"/>
	Off	<input type="checkbox"/>	<input type="checkbox"/>	<input type="radio"/>	<input type="radio"/>	<input type="radio"/>	<input type="radio"/>	<input type="radio"/>
	External	<input type="checkbox"/>	<input type="checkbox"/>	<input type="radio"/>	<input type="radio"/>	<input type="radio"/>	<input type="radio"/>	<input type="radio"/>
LCD Monitor Setting (p. 63)	Off	<input type="checkbox"/>	<input type="checkbox"/>	<input type="radio"/>	<input type="radio"/>	<input type="radio"/>	<input type="radio"/>	<input type="radio"/>
	No Information	<input type="checkbox"/>	<input type="checkbox"/>	<input type="radio"/>	<input type="radio"/>	<input type="radio"/>	<input type="radio"/>	<input type="radio"/>
	Information View	<input type="checkbox"/>	<input type="checkbox"/>	<input type="radio"/>	<input type="radio"/>	<input type="radio"/>	<input type="radio"/>	<input type="radio"/>
Stitch Direction Selection (Right, Left, Top, Bottom, 2 × 2) (p. 102)		<input type="checkbox"/>	<input type="checkbox"/>	<input type="checkbox"/>	<input type="checkbox"/>	<input type="checkbox"/>	<input type="checkbox"/>	<input type="checkbox"/>
AF Frame (p. 121)	Face Detect	<input type="checkbox"/>	<input type="checkbox"/>	<input type="radio"/>	<input type="radio"/>	<input type="radio"/>	<input type="radio"/>	<input type="radio"/>
	AiAF (9-point)	<input type="checkbox"/>	<input type="checkbox"/>	<input type="radio"/>	<input type="radio"/>	<input type="radio"/>	<input type="radio"/>	<input type="radio"/>
	Center	<input type="checkbox"/>	<input type="checkbox"/>	<input type="checkbox"/>	<input type="checkbox"/>	<input type="checkbox"/>	<input type="checkbox"/>	<input type="radio"/>
	FlexiZone	<input type="checkbox"/>	<input type="checkbox"/>	<input type="radio"/>	<input type="radio"/>	<input type="radio"/>	<input type="radio"/>	<input type="checkbox"/>
AF-Point Zoom (p. 116)		<input type="checkbox"/>	<input type="checkbox"/>	<input type="radio"/>	<input type="radio"/>	<input type="radio"/>	<input type="radio"/>	<input type="radio"/>
Servo AF (p. 127)		<input type="checkbox"/>	<input type="checkbox"/>	<input type="radio"/>	<input type="radio"/>	<input type="radio"/>	<input type="radio"/>	<input type="radio"/>
AF Mode ⁸⁾ (p. 120)	Continuous	<input type="checkbox"/>	<input type="checkbox"/>	<input type="radio"/>	<input type="radio"/>	<input type="radio"/>	<input type="radio"/>	<input type="radio"/>
	Single	<input type="checkbox"/>	<input type="checkbox"/>	<input type="radio"/>	<input type="radio"/>	<input type="radio"/>	<input type="radio"/>	<input type="radio"/>
Digital Zoom ⁹⁾ (p. 69)	Standard	<input type="checkbox"/>	<input type="checkbox"/>	<input type="radio"/>	<input type="radio"/>	<input type="radio"/>	<input type="radio"/>	<input type="radio"/>
	Digital Tele-converter	<input type="checkbox"/>	<input type="checkbox"/>	<input type="radio"/>	<input type="radio"/>	<input type="radio"/>	<input type="radio"/>	<input type="radio"/>
Built-in Flash Control (p. 113)	Flash Output	Auto	<input type="checkbox"/>	<input type="checkbox"/>	<input type="checkbox"/>	<input type="radio"/>	<input type="radio"/>	<input type="radio"/>
		Manual	<input type="checkbox"/>	<input type="checkbox"/>	<input type="radio"/>	<input type="radio"/>	<input type="radio"/>	<input type="checkbox"/>
	Red-Eye Correction	<input type="checkbox"/>	<input type="checkbox"/>	<input type="radio"/>	<input type="radio"/>	<input type="radio"/>	<input type="radio"/>	<input type="radio"/>
	Red-Eye Lamp	<input type="checkbox"/>	<input type="checkbox"/>	<input type="radio"/>	<input type="radio"/>	<input type="radio"/>	<input type="radio"/>	<input type="radio"/>
	Flash Exp. Comp	<input type="checkbox"/>	<input type="checkbox"/>	<input type="checkbox"/>	<input type="radio"/>	<input type="radio"/>	<input type="radio"/>	<input type="checkbox"/>
	Flash Output	<input type="checkbox"/>	<input type="checkbox"/>	<input type="radio"/>	<input type="radio"/>	<input type="radio"/>	<input type="checkbox"/>	<input type="checkbox"/>
	Shutter Sync. (1st curtain, 2nd curtain)	<input type="checkbox"/>	<input type="checkbox"/>	<input type="radio"/>	<input type="radio"/>	<input type="radio"/>	<input type="radio"/>	<input type="checkbox"/>
	Slow Synchro	<input type="checkbox"/>	<input type="checkbox"/>	<input type="radio"/>	<input type="radio"/>	<input type="radio"/>	<input type="radio"/>	<input type="checkbox"/>
	Safety FE	<input type="checkbox"/>	<input type="checkbox"/>	<input type="checkbox"/>	<input type="radio"/>	<input type="radio"/>	<input type="radio"/>	<input type="checkbox"/>
i-Contrast (p. 138)		<input type="checkbox"/>	<input type="checkbox"/>	<input type="radio"/>	<input type="radio"/>	<input type="radio"/>	<input type="radio"/>	<input type="radio"/>
Drive Setting (p. 75)	FaceSelf-timer	<input type="checkbox"/>	<input type="checkbox"/>	<input type="radio"/>	<input type="radio"/>	<input type="radio"/>	<input type="radio"/>	<input type="radio"/>
	Self-timer	<input type="checkbox"/>	<input type="checkbox"/>	<input type="radio"/>	<input type="radio"/>	<input type="radio"/>	<input type="radio"/>	<input type="radio"/>
	Custom Timer	<input type="checkbox"/>	<input type="checkbox"/>	<input type="radio"/>	<input type="radio"/>	<input type="radio"/>	<input type="radio"/>	<input type="radio"/>
Spot AE Point (p. 142)	Center	<input type="checkbox"/>	<input type="checkbox"/>	<input type="radio"/>	<input type="radio"/>	<input type="radio"/>	<input type="radio"/>	<input type="checkbox"/>
	AF Point	<input type="checkbox"/>	<input type="checkbox"/>	<input type="radio"/>	<input type="radio"/>	<input type="radio"/>	<input type="radio"/>	<input type="checkbox"/>
Safety Shift (p. 97)		<input type="checkbox"/>	<input type="checkbox"/>	<input type="checkbox"/>	<input type="radio"/>	<input type="radio"/>	<input type="checkbox"/>	<input type="checkbox"/>
Auto ISO Shift (p. 88)		<input type="checkbox"/>	<input type="checkbox"/>	<input type="checkbox"/>	<input type="radio"/>	<input type="checkbox"/>	<input type="radio"/>	<input type="radio"/>
MF-Point Zoom (p. 130)		<input type="checkbox"/>	<input type="checkbox"/>	<input type="radio"/>	<input type="radio"/>	<input type="radio"/>	<input type="radio"/>	<input type="checkbox"/>
Safety MF (p. 131)		<input type="checkbox"/>	<input type="checkbox"/>	<input type="radio"/>	<input type="radio"/>	<input type="radio"/>	<input type="radio"/>	<input type="checkbox"/>

SCN																			
														ISO 3200					
○	○	○	○	○	○	○	○	○	○	○	○	○	○	○	○	○	○	○	○
-	-	-	-	-	-	-	-	-	-	-	-	-	-	-	-	-	-	-	-
○	○	-	○	○	○	○	○	○	○	○	-	○	○	○	○	-	○	○	
○	○	-	○	○	○	○	○	○	○	○	-	○	○	○	○	-	-	-	
○	○	-	○	○	○	○	○	○	○	○	-	○	○	-	○	-	-	-	
○	○	-	○	○	○	○	○	○	○	○	-	○	○	-	○	-	-	-	
○	○	-	○	○	○	○	○	○	○	○	○	○	○	-	-	-	-	-	
○	○	○	○	○	○	○	○	○	○	○	○	○	○	○	○	○	○	○	
○	○	○	○	○	○	○	○	○	○	○	○	○	○	○	-	○	○	-	
-	-	-	-	-	-	-	-	-	-	-	-	-	-	-	○	-	-	-	
○	○	-	○	○	○	○	○	○	○	○	-	○	○	○	○	-	-	-	
○	○	-	○	○	○	○	○	○	○	○	-	○	○	○	○	-	○	○	
○	○	○	○	○	○	○	○	○	○	○	○	○	○	○	○	○	○	-	
-	-	-	-	-	-	-	-	-	-	-	-	-	-	-	-	-	-	-	
○	○	-	○	○	○	○	○	○	○	○	○	○	○	○	○	-	-	-	
○	○	○	○	○	○	○	○	○	○	○	-	○	○	○	○	○	-	-	
○	○	○	○	-	○	○	○	○	○	○	-	○	○	○	○	○	-	-	
○	○	-	○	○	○	○	○	○	○	○	○	○	○	○	○	○	○	○	
○	○	○	○	○	○	○	○	○	○	○	○	○	○	-	-	-	○	-	
○	○	○	○	○	○	○	○	○	○	○	○	○	○	-	-	-	-	-	
○	○	-	○	○	○	○	○	○	○	○	-	○	○	-	○	○	-	-	
-	-	-	-	-	-	-	-	-	-	-	-	-	-	-	-	-	-	-	
○	○	-	○	○	○	○	○	○	○	○	-	○	○	○	-	-	-	-	
○	○	-	○	○	○	○	○	○	○	○	-	○	○	○	-	-	-	-	
-	-	-	-	-	-	-	-	-	-	-	-	-	-	-	-	-	-	-	
-	-	-	-	-	-	-	-	-	-	-	-	-	-	-	-	-	-	-	
-	-	-	-	-	-	-	-	-	-	-	-	-	-	-	-	-	-	-	
-	○ ¹⁰	-	○ ¹⁰	-	-	○ ¹⁰	○ ¹⁰	-	-	-	-	-	-	-	-	○	-	-	
-	-	-	-	-	-	-	-	-	-	-	-	-	-	-	-	-	-	-	
-	-	-	-	-	-	-	-	-	-	-	-	-	-	-	-	-	-	-	
○	○	-	○	○	○	○	○	○	○	○	-	○	○	○	-	-	-	-	
○	○	-	○	○	○	○	○	○	○	○	○	○	○	○	○	○	○	○	
○	○	-	○	○	○	○	○	○	○	○	-	○	○	○	-	-	-	-	
-	-	-	-	-	-	-	-	-	-	-	-	-	-	-	-	-	-	-	
-	-	-	-	-	-	-	-	-	-	-	-	-	-	-	-	-	-	-	
-	-	-	-	-	-	-	-	-	-	-	-	-	-	-	-	-	-	-	
○	○	-	○	○	○	○	○	○	○	○	-	○	○	○	○	-	-	-	
○	○	-	○	○	○	○	○	○	○	○	-	○	○	○	○	-	○	○	

Function		Shooting Mode						
		C1	C2	M	Av	Tv	P	AUTO
AF-assist Beam (p. 56)		<input type="checkbox"/>	<input type="checkbox"/>	<input type="radio"/>	<input type="radio"/>	<input type="radio"/>	<input type="radio"/>	<input type="radio"/>
Review (Rec. review) (p. 56)		<input type="checkbox"/>	<input type="checkbox"/>	<input type="radio"/>	<input type="radio"/>	<input type="radio"/>	<input type="radio"/>	<input type="radio"/>
Review Info (p. 56)	Off	<input type="checkbox"/>	<input type="checkbox"/>	<input type="radio"/>	<input type="radio"/>	<input type="radio"/>	<input type="radio"/>	<input type="radio"/>
	Detailed/Focus Check	<input type="checkbox"/>	<input type="checkbox"/>	<input type="radio"/>	<input type="radio"/>	<input type="radio"/>	<input type="radio"/>	<input type="radio"/>
Save Original (p. 153)		—	—	—	—	—	—	—
Auto Category (p. 154)		<input type="checkbox"/>	<input type="checkbox"/>	<input type="radio"/>	<input type="radio"/>	<input type="radio"/>	<input type="radio"/>	<input type="radio"/>
IS Mode (p. 85)	Continuous	<input type="checkbox"/>	<input type="checkbox"/>	<input type="radio"/>	<input type="radio"/>	<input type="radio"/>	<input type="radio"/>	<input type="radio"/>
	Shoot Only/Panning	<input type="checkbox"/>	<input type="checkbox"/>	<input type="radio"/>	<input type="radio"/>	<input type="radio"/>	<input type="radio"/>	<input type="radio"/>
Converter (p. 263)		<input type="checkbox"/>	<input type="checkbox"/>	<input type="radio"/>	<input type="radio"/>	<input type="radio"/>	<input type="radio"/>	<input type="radio"/>
Record RAW+L, Fine (JPEG) (p. 84)		<input type="checkbox"/>	<input type="checkbox"/>	<input type="radio"/>	<input type="radio"/>	<input type="radio"/>	<input type="radio"/>	—
Custom Display (p. 66)	Shooting Info.	<input type="checkbox"/>	<input type="checkbox"/>	<input type="radio"/>	<input type="radio"/>	<input type="radio"/>	<input type="radio"/>	<input type="radio"/>
	Grid Lines	<input type="checkbox"/>	<input type="checkbox"/>	<input type="radio"/>	<input type="radio"/>	<input type="radio"/>	<input type="radio"/>	<input type="radio"/>
	3:2 Guide	<input type="checkbox"/>	<input type="checkbox"/>	<input type="radio"/>	<input type="radio"/>	<input type="radio"/>	<input type="radio"/>	<input type="radio"/>
	Histogram	<input type="checkbox"/>	<input type="checkbox"/>	<input type="radio"/>	<input type="radio"/>	<input type="radio"/>	<input type="radio"/>	<input type="checkbox"/>
Registering settings to the Shortcut button (p. 155)		<input type="checkbox"/>	<input type="checkbox"/>	<input type="radio"/>	<input type="radio"/>	<input type="radio"/>	<input type="radio"/>	<input type="radio"/>
Custom Settings (Saved in the C1/C2) (p. 109)		<input type="radio"/>	<input type="radio"/>	<input type="radio"/>	<input type="radio"/>	<input type="radio"/>	<input type="radio"/>	—

- : Setting available or optimum value is automatically set by the camera. As a rule, with Stitch Assist, only the first image is available.
- : Setting available (depending on the shooting mode saved in Custom mode)
- △ : Selectable only, no settings available.
- : Not available.

- 1) Set to optimum value depending on each shooting mode.
- 2) Fix to ISO 3200.
- 3) Set to Continuous Shooting LV when Manual Focus or Fireworks is selected.
- 4) Fix to M3 (1600 × 1200)
- 5) **W** is not available.
- 6) Only Av (Aperture Value) can be set.
- 7) Only Tv (Shutter Speed) can be set.
- 8) Single is only available when AiAF (9-points) is selected.
- 9) **RAW** and **W** are not available.
- 10) Always set to on.
- 11) Available when the flash fires.



Canon